



A&M has developed and produced premium Quality products and solutions for the die-making and die-cutting industry since 1995.

We provide our partners high level experience to ensure the best possible end result that contains and ensures high-quality, premium products.

This catalogue contains our most common products and services. For further queries please don't hesitate to contact us.

How to reach us: **Phone:** +49 (0) 7151 910 500 0
 Fax: +49 (0) 7151 910 500 9
 Email: info@aundm.eu

Please feel free to visit us online at www.AundM.eu or on Youtube under A&M Die Supplies.

We appreciate to hear from you!

Perfect in die-supplies

Index

Creasing Matrix	Page	3
Make Ready	Page	20
Counter Plates	Page	21
VHM- Millers	Page	24
Plotter Accessories	Page	25
Nicking & Accesories	Page	28
Stripper die-parts	Page	33
Rotary Supplies	Page	41
Tools & Accessories	Page	49
PerfaTypes	Page	50
Tools	Page	54
Accessories	Page	55
Ejection Material	Page	56
Sheets	Page	57
Strips / Trapezes / Waves	Page	68
Foam Sheets / Strips	Page	72
Profiles	Page	76
Glue	Page	81
Cutting Rules	Page	82
Benchtools and machinery	Page	89
Storage systems	Page	91
Dieguard 2.0	Page	95
General terms of sale	Page	97

A&M[®] Creasing Matrix

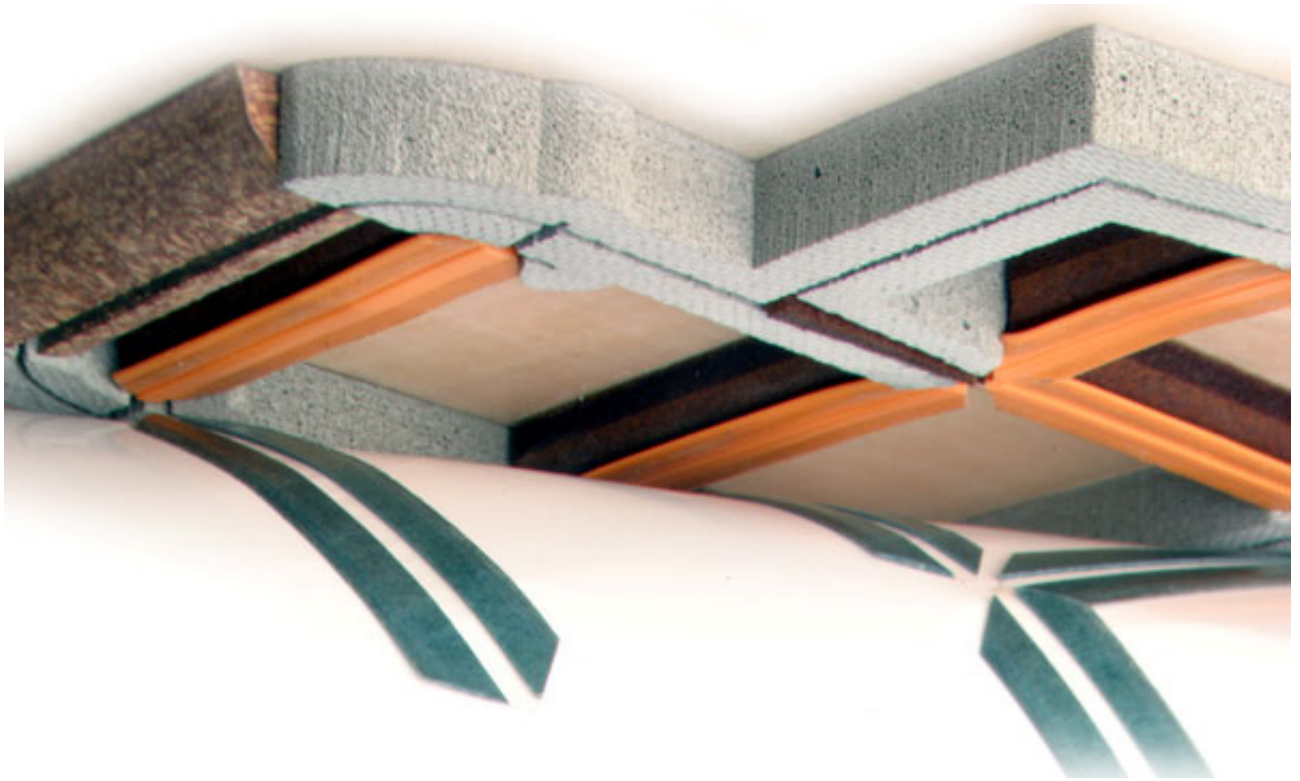

Perfect in die-supplies

A&M[®]Max

A&MMax, the Creasing Matrix from **A&M**.

A&MMax offers the following advantages:

- Customizing the creasing matrix effortlessly with the knives.
- No fading on the cutting plate by adhesives with extreme high adhesive force.
- No snagging cartons through the bevelled edges.
- Optimal solution for any cardboard or corrugated board's thicknesses.
- Locator for different creasing rules dimensions.
- Great adhesiveness even at high temperatures.
- Easy to remove the foil through Easymount.



Selection of the **A&M**Max-dimensions:

Pressboard thickness:

Slightly below the the cutting thickness

Example: Carton thickness = Pressboard thickness

Channel width:

Creasing rule thickness + 1,5 times cutting thickness 1/63 in

Example :	Creasing rule	1/36 in
	Carton 1/63 + 1/126 (=50%)	+ <u>2/85 in</u>
		2/39 in

Dimension 2/39 x 1/63 in



A&Max AB Creasing Matrix

High quality creasing matrix made of pressboard, film base

Item no.	Depth (in.)	Width (in.)	Locator pt.	Packed by
78-AB-030060	1/85	2/85	2/4	47 x 29,5 in = 115 ft
78-AB-030080	1/85	1/32	2/4	47 x 29,5 in = 115 ft
78-AB-030100	1/85	3/76	2/4	47 x 29,5 in = 115 ft
78-AB-030110	1/85	1/23	2/4	47 x 29,5 in = 115 ft
78-AB-030120	1/85	1/21	2/4	47 x 29,5 in = 115 ft
78-AB-030130	1/85	2/39	2/4	47 x 29,5 in = 115 ft
78-AB-030150	1/85	1/17	2/4	47 x 29,5 in = 115 ft
78-AB-030170	1/85	1/15	2/4	47 x 29,5 in = 115 ft
78-AB-040080	1/63	1/32	2/4	47 x 29,5 in = 115 ft
78-AB-040100	1/63	3/76	2/4	47 x 29,5 in = 115 ft
78-AB-040110	1/63	1/23	2/4	47 x 29,5 in = 115 ft
78-AB-040120	1/63	1/21	2/4	47 x 29,5 in = 115 ft
78-AB-040130	1/63	2/39	2/4	47 x 29,5 in = 115 ft
78-AB-040140	1/63	1/18	2/4	47 x 29,5 in = 115 ft
78-AB-040150	1/63	1/17	2/4	47 x 29,5 in = 115 ft
78-AB-040170	1/63	1/15	2/4	47 x 29,5 in = 115 ft
78-AB-050100	1/51	3/76	2/4	47 x 29,5 in = 115 ft
78-AB-050120	1/51	1/21	2/4	47 x 29,5 in = 115 ft
78-AB-050130	1/51	2/39	2/4	47 x 29,5 in = 115 ft
78-AB-050140	1/51	1/18	2/4	47 x 29,5 in = 115 ft
78-AB-050150	1/51	1/17	2/4	47 x 29,5 in = 115 ft
78-AB-050160	1/51	1/16	2/4	47 x 29,5 in = 115 ft
78-AB-050170	1/51	1/15	2/4	47 x 29,5 in = 115 ft
78-AB-050190	1/51	3/40	2/4	47 x 29,5 in = 115 ft
78-AB-050210	1/51	1/12	2/4	47 x 29,5 in = 115 ft
78-AB-060120	2/85	1/21	2/4	47 x 29,5 in = 115 ft
78-AB-060130	2/85	2/39	2/4	47 x 29,5 in = 115 ft
78-AB-060150	2/85	1/17	2/4	47 x 29,5 in = 115 ft
78-AB-060160	2/85	1/16	2/4	47 x 29,5 in = 115 ft
78-AB-060170	2/85	1/15	2/4	47 x 29,5 in = 115 ft
78-AB-060190	2/85	3/40	2/4	47 x 29,5 in = 115 ft
78-AB-060210	2/85	1/12	2/4	47 x 29,5 in = 115 ft
78-AB-060230	2/85	1/11	2/4	47 x 29,5 in = 115 ft
78-AB-060250	2/85	6/61	2/4	47 x 29,5 in = 115 ft
78-AB-060270	2/85	5/47	2/4	47 x 29,5 in = 115 ft
78-AB-060300	2/85	2/17	2/4	47 x 29,5 in = 115 ft
78-AB-060320	2/85	1/8	2/4	47 x 29,5 in = 115 ft
78-AB-060350	2/85	4/29	2/4	47 x 29,5 in = 115 ft
78-AB-060400	2/85	3/19	2/4	47 x 29,5 in = 115 ft
78-AB-070170	1/36	1/15	2/4	47 x 29,5 in = 115 ft
78-AB-070190	1/36	3/40	2/4	47 x 29,5 in = 115 ft
78-AB-070210	1/36	1/12	2/4	47 x 29,5 in = 115 ft
78-AB-070220	1/36	2/23	2/4	47 x 29,5 in = 115 ft
78-AB-070230	1/36	1/11	2/4	47 x 29,5 in = 115 ft
78-AB-070250	1/36	6/61	2/4	47 x 29,5 in = 115 ft
78-AB-070270	1/36	5/47	2/4	47 x 29,5 in = 115 ft
78-AB-070300	1/36	2/17	2/4	47 x 29,5 in = 115 ft
78-AB-070320	1/36	1/8	2/4	47 x 29,5 in = 115 ft
78-AB-070350	1/36	4/29	2/4	47 x 29,5 in = 115 ft
78-AB-070400	1/36	3/19	2/4	47 x 29,5 in = 115 ft

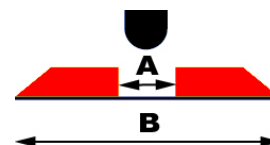

Further sizes upon request

A&Max AB Creasing Matrix

High quality creasing matrix made of pressboard, film base.

Item no.	Depth (in.)	Width (in.)	Locator pt.	Packed by
78-AB-080190	1/32	3/40	2/4	47 x 29,5 in = 115 ft
78-AB-080210	1/32	1/12	2/4	47 x 29,5 in = 115 ft
78-AB-080230	1/32	1/11	2/4	47 x 29,5 in = 115 ft
78-AB-080250	1/32	6/61	2/4	47 x 29,5 in = 115 ft
78-AB-080270	1/32	5/47	2/4	47 x 29,5 in = 115 ft
78-AB-080300	1/32	2/17	2/4	47 x 29,5 in = 115 ft
78-AB-080320	1/32	1/8	2/4	47 x 29,5 in = 115 ft
78-AB-080350	1/32	4/29	2/4	47 x 29,5 in = 115 ft
78-AB-080400	1/32	3/19	2/4	47 x 29,5 in = 115 ft
78-AB-080450	1/32	14/79	2/4	47 x 29,5 in = 115 ft
78-AB-080500	1/32	12/61	2/4	47 x 29,5 in = 115 ft
78-AB-080600	1/32	13/55	2/4	47 x 29,5 in = 115 ft
78-AB-100230	3/76	1/11	2/4	47 x 29,5 in = 115 ft
78-AB-100250	3/76	6/61	2/4	47 x 29,5 in = 115 ft
78-AB-100270	3/76	5/47	2/4	47 x 29,5 in = 115 ft
78-AB-100300	3/76	2/17	2/4	47 x 29,5 in = 115 ft
78-AB-100310	3/76	5/41	2/4	47 x 29,5 in = 115 ft
78-AB-100320	3/76	1/8	2/4	47 x 29,5 in = 115 ft
78-AB-100350	3/76	4/29	2/4	47 x 29,5 in = 115 ft
78-AB-100400	3/76	3/19	2/4	47 x 29,5 in = 115 ft
78-AB-100450	3/76	14/79	2/4	47 x 29,5 in = 115 ft
78-AB-100500	3/76	12/61	2/4	47 x 29,5 in = 115 ft
78-AB-100600	3/76	13/55	2/4	47 x 29,5 in = 115 ft
78-AB-120450	1/21	14/79	2/4	47 x 29,5 in = 115 ft
78-AB-120500	1/21	12/61	2/4	47 x 29,5 in = 115 ft
78-AB-120600	1/21	13/55	2/4	47 x 29,5 in = 115 ft
78-AB-140400	1/18	3/19	2/4	47 x 29,5 in = 115 ft
78-AB-140500	1/18	12/61	2/4	47 x 29,5 in = 115 ft
78-AB-140600	1/18	13/55	2/4	47 x 29,5 in = 115 ft
78-AB-150500	1/17	12/61	2/4	47 x 29,5 in = 115 ft
78-AB-160400	1/16	3/19	2/4	47 x 29,5 in = 115 ft
78-AB-160500	1/16	12/61	2/4	47 x 29,5 in = 115 ft
78-AB-160600	1/16	13/55	2/4	47 x 29,5 in = 115 ft

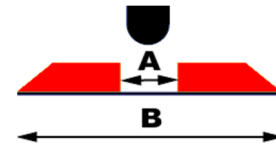

A&Max SV Creasing Matrix

High quality creasing matrix made of pressboard, film base with chamfered edges inside. Reduces the tensile stress and avoids cracking of the material.

Item no.	Depth (in.)	Width (in.)	Locator pt.	Packed by
78-SV-050130	1/51	2/39	2/4	47 x 29,5 in = 115 ft
78-SV-050150	1/51	1/17	2/4	47 x 29,5 in = 115 ft
78-SV-050170	1/51	1/15	2/4	47 x 29,5 in = 115 ft
78-SV-060210	2/85	1/12	2/4	47 x 29,5 in = 115 ft
78-SV-060230	2/85	1/11	2/4	47 x 29,5 in = 115 ft
78-SV-060250	2/85	6/61	2/4	47 x 29,5 in = 115 ft
78-SV-060270	2/85	5/47	2/4	47 x 29,5 in = 115 ft
78-SV-060300	2/85	2/17	2/4	47 x 29,5 in = 115 ft
78-SV-060350	2/85	4/29	2/4	47 x 29,5 in = 115 ft
78-SV-060400	2/85	3/19	2/4	47 x 29,5 in = 115 ft



Further sizes upon request

A&Max SV Creasing Matrix

High quality creasing matrix made of pressboard, film base with chamfered edges inside. Reduces the tensile stress and avoids cracking of the material.

Item no.	Depth (in.)	Width (in.)	Locator pt.	Packed by
78-SV-070230	1/36	1/11	2/4	47 x 29,5 in = 115 ft
78-SV-070250	1/36	6/61	2/4	47 x 29,5 in = 115 ft
78-SV-070270	1/36	5/47	2/4	47 x 29,5 in = 115 ft
78-SV-070280	1/36	1/9	2/4	47 x 29,5 in = 115 ft
78-SV-070300	1/36	2/17	2/4	47 x 29,5 in = 115 ft
78-SV-070400	1/36	3/19	2/4	47 x 29,5 in = 115 ft
78-SV-080270	1/32	5/47	2/4	47 x 29,5 in = 115 ft
78-SV-080300	1/32	2/17	2/4	47 x 29,5 in = 115 ft
78-SV-080320	1/32	1/8	2/4	47 x 29,5 in = 115 ft
78-SV-080350	1/32	4/29	2/4	47 x 29,5 in = 115 ft
78-SV-080400	1/32	3/19	2/4	47 x 29,5 in = 115 ft
78-SV-080500	1/32	12/61	2/4	47 x 29,5 in = 115 ft
78-SV-100300	3/76	2/17	2/4	47 x 29,5 in = 115 ft
78-SV-100320	3/76	1/8	2/4	47 x 29,5 in = 115 ft
78-SV-100350	3/76	4/29	2/4	47 x 29,5 in = 115 ft
78-SV-100400	3/76	3/19	2/4	47 x 29,5 in = 115 ft
78-SV-100500	3/76	12/61	2/4	47 x 29,5 in = 115 ft

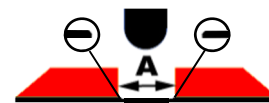

A&Max S Creasing Matrix

High quality creasing matrix made of pressboard, film base. Extra small with 3 mm pressboard width instead of 6 mm.

Item no.	Depth (in.)	Width (in.)	Locator pt.	Packed by
78-S-030080	1/85	1/32	2/3	94 x 29,5 in = 230 ft
78-S-030100	1/85	3/76	2/3	94 x 29,5 in = 230 ft
78-S-030120	1/85	1/21	2/3	94 x 29,5 in = 230 ft
78-S-030130	1/85	2/39	2/3	94 x 29,5 in = 230 ft
78-S-030150	1/85	1/17	2/3	94 x 29,5 in = 230 ft
78-S-040080	1/63	1/32	2/3	94 x 29,5 in = 230 ft
78-S-040100	1/63	3/76	2/3	94 x 29,5 in = 230 ft
78-S-040120	1/63	1/21	2/3	94 x 29,5 in = 230 ft
78-S-040130	1/63	2/39	2/3	94 x 29,5 in = 230 ft
78-S-040140	1/63	1/18	2/3	94 x 29,5 in = 230 ft
78-S-040150	1/63	1/17	2/3	94 x 29,5 in = 230 ft
78-S-040170	1/63	1/15	2/3	94 x 29,5 in = 230 ft
78-S-050080	1/51	1/32	2/3	94 x 29,5 in = 230 ft
78-S-050100	1/51	3/76	2/3	94 x 29,5 in = 230 ft
78-S-050120	1/51	1/21	2/3	94 x 29,5 in = 230 ft
78-S-050130	1/51	2/39	2/3	94 x 29,5 in = 230 ft
78-S-050140	1/51	1/18	2/3	94 x 29,5 in = 230 ft
78-S-050150	1/51	1/17	2/3	94 x 29,5 in = 230 ft
78-S-050170	1/51	1/15	2/3	94 x 29,5 in = 230 ft
78-S-050190	1/51	3/40	2/3	94 x 29,5 in = 230 ft
78-S-060130	2/85	2/39	2/3	94 x 29,5 in = 230 ft
78-S-060150	2/85	1/17	2/3	94 x 29,5 in = 230 ft
78-S-060170	2/85	1/15	2/3	94 x 29,5 in = 230 ft
78-S-060190	2/85	3/40	2/3	94 x 29,5 in = 230 ft
78-S-060250	2/85	6/61	2/3	94 x 29,5 in = 230 ft
78-S-080230	1/32	1/11	2/3	94 x 29,5 in = 230 ft

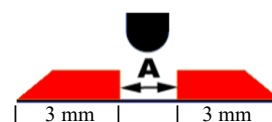

Further sizes upon request

A&Max ABC Creasing Matrix

High quality creasing matrix made of pressboard, film base (on reels).

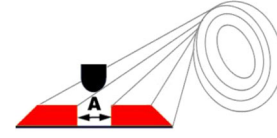

Item no.	Depth (in.)	Width (in.)	Locator pt.	Packed by
78-ABC-030130	1/85	2/39	2/4	Reel = 121 ft
78-ABC-040100	1/63	3/76	2/4	Reel = 121 ft
78-ABC-040120	1/63	1/21	2/4	Reel = 121 ft
78-ABC-060250	2/85	6/61	2/4	Reel = 115 ft
78-ABC-060270	2/85	5/47	2/4	Reel = 115 ft
78-ABC-060320	2/85	1/8	2/4	Reel = 115 ft
78-ABC-070170	1/36	1/15	2/4	Reel = 65 ft
78-ABC-070230	1/36	1/11	2/4	Reel = 65 ft
78-ABC-080250	1/32	6/61	2/4	Reel = 65 ft
78-ABC-080270	1/32	5/47	2/4	Reel = 65 ft
78-ABC-080300	1/32	2/17	2/4	Reel = 65 ft
78-ABC-080320	1/32	1/8	2/4	Reel = 65 ft
78-ABC-080350	1/32	4/29	2/4	Reel = 65 ft
78-ABC-080400	1/32	3/19	2/4	Reel = 65 ft
78-ABC-100300	3/76	2/17	2/4	Reel = 65 ft
78-ABC-100350	3/76	4/29	2/4	Reel = 65 ft
78-ABC-100400	3/76	3/19	2/4	Reel = 65 ft

A&Max OC Creasing Matrix

Off-Center High quality creasing matrix made of pressboard, film base. For small distances between rules. 2mm pressboard width at the straight edged side.

Item no.	Depth (in.)	Width (in.)	Locator pt.	Packed by
78-OC-030100	1/85	3/76	2/4	20 x 29,5 in = 49 ft
78-OC-030120	1/85	2/39	2/4	20 x 29,5 in = 49 ft
78-OC-030130	1/85	2/39	2/4	20 x 29,5 in = 49 ft
78-OC-030150	1/85	1/17	2/4	20 x 29,5 in = 49 ft
78-OC-040100	1/63	3/76	2/4	20 x 29,5 in = 49 ft
78-OC-040120	1/63	1/21	2/4	20 x 29,5 in = 49 ft
78-OC-040130	1/63	2/39	2/4	20 x 29,5 in = 49 ft
78-OC-040150	1/63	1/17	2/4	20 x 29,5 in = 49 ft
78-OC-040170	1/63	1/15	2/4	20 x 29,5 in = 49 ft
78-OC-040190	1/63	3/40	2/4	20 x 29,5 in = 49 ft
78-OC-050100	1/51	3/76	2/4	20 x 29,5 in = 49 ft
78-OC-050120	1/51	1/21	2/4	20 x 29,5 in = 49 ft
78-OC-050130	1/51	2/39	2/4	20 x 29,5 in = 49 ft
78-OC-050150	1/51	1/17	2/4	20 x 29,5 in = 49 ft
78-OC-050170	1/51	1/15	2/4	20 x 29,5 in = 49 ft
78-OC-060150	2/85	1/17	2/4	20 x 29,5 in = 49 ft
78-OC-060170	2/85	1/15	2/4	20 x 29,5 in = 49 ft
78-OC-060190	2/85	3/40	2/4	20 x 29,5 in = 49 ft
78-OC-070230	1/36	1/11	2/4	20 x 29,5 in = 49 ft
78-OC-080250	1/32	6/61	2/4	20 x 29,5 in = 49 ft
78-OC-080270	1/32	5/47	2/4	20 x 29,5 in = 49 ft
78-OC-080300	1/32	2/17	2/4	20 x 29,5 in = 49 ft
78-OC-100300	3/76	4/29	2/4	20 x 29,5 in = 49 ft

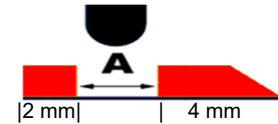

Further sizes upon request

A&Max Classic Creasing Matrix

High quality creasing matrix made of plastic, steel base.

Item no.	Depth (in.)	Width (in.)	Locator pt.	Packed by
79C-038056	1/67	2/91	2/3/4	79 ft
79C-038080	1/67	1/32	2/3/4	79 ft
79C-038100	1/67	3/76	2/3/4	79 ft
79C-038130	1/67	2/39	2/3/4	79 ft
79C-043130	1/59	2/39	2/3/4	79 ft
79C-043150	1/59	1/17	2/3/4	79 ft
79C-045140	1/56	1/18	2/3/4	79 ft
79C-048150	1/53	1/17	2/3/4	79 ft
79C-048170	1/53	1/15	2/3/4	79 ft
79C-053170	1/48	1/15	2/3/4	79 ft
79C-053190	1/48	3/40	2/3/4	79 ft
79C-055130	1/46	2/39	2/3/4	79 ft
79C-058190	1/44	3/40	2/3/4	79 ft
79C-058210	1/44	1/12	2/3/4	79 ft
79C-063210	1/40	1/12	2/3/4	79 ft
79C-068230	2/75	1/11	2/3/4	79 ft
79C-070150	1/36	1/17	2/3/4	79 ft
79C-070240	1/36	5/53	2/3/4	79 ft
79C-079270	1/32	5/47	2/3/4	79 ft
79C-080190	1/32	3/40	2/3/4	79 ft
79C-090230	1/28	1/11	2/3/4	79 ft
79C-100300	3/76	2/17	3/4/6	39 ft
79C-100300.8	3/76	2/17	8	39 ft
79C-130300	2/39	2/17	2/3/4	39 ft
79C-130380	2/39	3/20	3/4/6	39 ft
79C-130380.8	2/39	3/20	8	39 ft
79C-160380	1/16	3/20	2/3/4	39 ft
79C-160500	1/16	12/61	3/4/6	39 ft
79C-160500.6	1/16	12/61	6	39 ft
79C-160500.68	1/16	12/61	6/8	39 ft
79C-200380	3/38	3/20	2/3/4	39 ft
79C-200500	3/38	12/61	2/3/4	39 ft
79C-200630	3/38	1/4	3/4/6	39 ft
79C-200630.68	3/38	1/4	6/8	39 ft

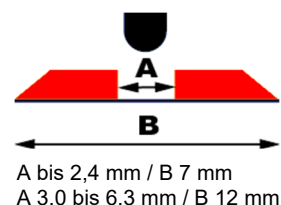

A&Max Classic Offcenter Creasing Matrix

Off-Center High quality creasing matrix made of plastic, steel base. For narrow spaces between rules. 2mm width at the straight edged side.

Item no.	Depth (in.)	Width (in.)	Locator pt.	Packed by
79C-OC-038080	1/67	1/32	2/3/4	79 ft
79C-OC-038100	1/67	3/76	2/3/4	79 ft
79C-OC-038120	1/67	1/21	2/3/4	79 ft
79C-OC-038130	1/67	2/39	2/3/4	79 ft
79C-OC-043130	1/59	2/39	2/3/4	79 ft
79C-OC-043150	1/59	1/17	2/3/4	79 ft
79C-OC-045140	1/56	1/18	2/3/4	79 ft
79C-OC-048150	1/53	1/17	2/3/4	79 ft

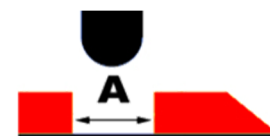

A&Max Classic Multcrease Creasing Matrix

High quality creasing matrix made of plastic, steel base for double creasing rule (Total width= 12 mm)

Item no.	Depth (in.)	Width (in.)	Locator pt.	Gap	Packed by
79C-MC-038100300	1/67	3/76	2/3	2/17	39 ft
79C-MC-038100350	1/67	3/76	2/3	4/29	39 ft
79C-MC-038100400	1/67	3/76	2/3	3/19	39 ft
79C-MC-038100500	1/67	3/76	2/3	12/61	39 ft
79C-MC-043130300	1/59	2/39	2/3	2/17	39 ft
79C-MC-043130400	1/59	2/39	2/3	3/19	39 ft
79C-MC-043130500	1/59	2/39	2/3	12/61	39 ft
79C-MC-048150300	1/53	1/17	2/3	2/17	39 ft
79C-MC-048150350	1/53	1/17	2/3	4/29	39 ft
79C-MC-048150400	1/53	1/17	2/3	3/19	39 ft
79C-MC-048150500	1/53	1/17	2/3	12/61	39 ft



A&Max Classic Reverse Bend Creasing Matrix

High quality creasing matrix made of plastic, steel base for reverse creasing.

Item no.	Size A (in.)	Size B x D (in.)	Size C (in.)	Height E (in.)	Packed by
79C-RB-RB1	3/38	1/51 x 1/36	1/85	48/53	59 ft
79C-RB-RB2	5/47	1/36 x 3/76	1/85	35/39	59 ft
79C-RB-RB3	3/19	1/28 x 1/17	1/85	8/9	59 ft
79C-RB-RB4	14/79	1/23 x 3/38	1/85	15/17	59 ft
79C-RB-RB5	12/61	2/39 x 3/38	1/85	13/15	59 ft
79C-RB-RB6	13/55	1/14 x 2/17	1/85	41/48	59 ft

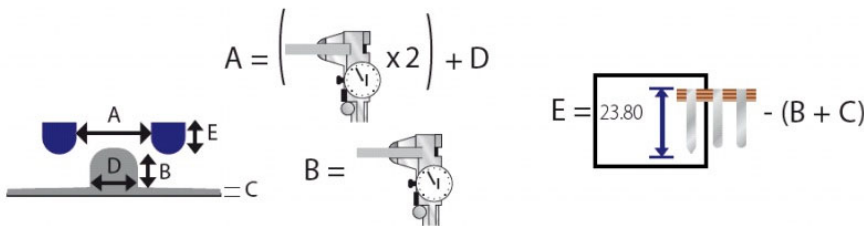

A&Max Fix Creasing Matrix

High quality creasing matrix made of plastic, film base

Item no.	Depth (in.)	Width (in.)	Locator pt.	Packed by
79F-030060	1/85	2/85	2/3/4	79 ft
79F-030080	1/85	1/32	2/3/4	79 ft
79F-030100	1/85	3/76	2/3/4	79 ft
79F-030110	1/85	1/23	2/3/4	79 ft
79F-030120	1/85	1/21	2/3/4	79 ft
79F-030130	1/85	2/39	2/3/4	79 ft
79F-030140	1/85	1/18	2/3/4	79 ft
79F-030150	1/85	1/17	2/3/4	79 ft
79F-030160	1/85	1/16	2/3/4	79 ft
79F-030170	1/85	1/15	2/3/4	79 ft
79F-030190	1/85	3/40	2/3/4	79 ft
79F-030230	1/85	1/11	2/3/4	79 ft
79F-040050	1/63	1/51	2/3/4	79 ft
79F-040060	1/63	2/85	2/3/4	79 ft
79F-040080	1/63	1/32	2/3/4	79 ft
79F-040100	1/63	3/76	2/3/4	79 ft
79F-040110	1/63	1/23	2/3/4	79 ft
79F-040120	1/63	1/21	2/3/4	79 ft
79F-040130	1/63	2/39	2/3/4	79 ft
79F-040140	1/63	1/18	2/3/4	79 ft
79F-040150	1/63	1/17	2/3/4	79 ft
79F-040160	1/63	1/16	2/3/4	79 ft
79F-040170	1/63	1/15	2/3/4	79 ft
79F-040180	1/63	1/14	2/3/4	79 ft
79F-040190	1/63	3/40	2/3/4	79 ft
79F-040210	1/63	1/12	2/3/4	79 ft
79F-040270	1/63	5/47	2/3/4	79 ft
79F-045080	1/56	1/32	2/3/4	79 ft
79F-045100	1/56	3/76	2/3/4	79 ft
79F-045110	1/56	1/23	2/3/4	79 ft
79F-045120	1/56	1/21	2/3/4	79 ft
79F-045130	1/56	2/39	2/3/4	79 ft
79F-045140	1/56	1/18	2/3/4	79 ft
79F-045150	1/56	1/17	2/3/4	79 ft
79F-045160	1/56	1/16	2/3/4	79 ft
79F-045170	1/56	1/15	2/3/4	79 ft
79F-045190	1/56	3/40	2/3/4	79 ft
79F-050050	1/51	1/51	2/3/4	79 ft
79F-050080	1/51	1/32	2/3/4	79 ft
79F-050100	1/51	3/76	2/3/4	79 ft
79F-050110	1/51	1/23	2/3/4	79 ft
79F-050120	1/51	1/21	2/3/4	79 ft
79F-050130	1/51	2/39	2/3/4	79 ft
79F-050140	1/51	1/18	2/3/4	79 ft
79F-050150	1/51	1/17	2/3/4	79 ft
79F-050160	1/51	1/16	2/3/4	79 ft
79F-050170	1/51	1/15	2/3/4	79 ft
79F-050180	1/51	1/14	2/3/4	79 ft
79F-050190	1/51	3/40	2/3/4	79 ft

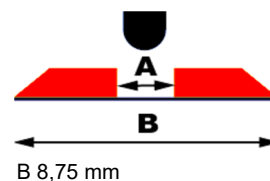

Further sizes upon
request

A&Max Fix Creasing Matrix

High quality creasing matrix made of plastic, film base

Item no.	Depth (in.)	Width (in.)	Locator pt.	Packed by
79F-050210	1/51	1/12	2/3/4	79 ft
79F-050230	1/51	1/11	2/3/4	79 ft
79F-050270	1/51	5/47	2/3/4	79 ft
79F-055080	1/46	1/32	2/3/4	79 ft
79F-055100	1/46	3/76	2/3/4	79 ft
79F-055110	1/46	1/23	2/3/4	79 ft
79F-055120	1/46	1/21	2/3/4	79 ft
79F-055130	1/46	2/39	2/3/4	79 ft
79F-055140	1/46	1/18	2/3/4	79 ft
79F-055150	1/46	1/17	2/3/4	79 ft
79F-055160	1/46	1/16	2/3/4	79 ft
79F-055170	1/46	1/15	2/3/4	79 ft
79F-055190	1/46	3/40	2/3/4	79 ft
79F-055210	1/46	1/12	2/3/4	79 ft
79F-055230	1/46	1/11	2/3/4	79 ft
79F-060100	2/85	3/76	2/3/4	79 ft
79F-060110	2/85	1/23	2/3/4	79 ft
79F-060120	2/85	1/21	2/3/4	79 ft
79F-060130	2/85	2/39	2/3/4	79 ft
79F-060140	2/85	1/18	2/3/4	79 ft
79F-060150	2/85	1/17	2/3/4	79 ft
79F-060160	2/85	1/16	2/3/4	79 ft
79F-060170	2/85	1/15	2/3/4	79 ft
79F-060180	2/85	1/14	2/3/4	79 ft
79F-060190	2/85	3/40	2/3/4	79 ft
79F-060210	2/85	1/12	2/3/4	79 ft
79F-060230	2/85	1/11	2/3/4	79 ft
79F-060250	2/85	6/61	2/3/4	79 ft
79F-060270	2/85	5/47	2/3/4	79 ft
79F-060300	2/85	2/17	2/3/4	79 ft
79F-060320	2/85	1/8	2/3/4	79 ft
79F-060350	2/85	4/29	2/3/4	79 ft
79F-060400	2/85	3/19	2/3/4	79 ft
79F-060450	2/85	14/79	2/3/4	79 ft
79F-060500	2/85	12/61	2/3/4	79 ft
79F-060500.6	2/85	12/61	6	79 ft
79F-060500.8	2/85	12/61	8	79 ft
79F-065100	1/39	3/76	2/3/4	79 ft
79F-065120	1/39	1/21	2/3/4	79 ft
79F-065130	1/39	2/39	2/3/4	79 ft
79F-065140	1/39	1/18	2/3/4	79 ft
79F-065150	1/39	1/17	2/3/4	79 ft
79F-065160	1/39	1/16	2/3/4	79 ft
79F-065170	1/39	1/15	2/3/4	79 ft
79F-065190	1/39	3/40	2/3/4	79 ft
79F-065210	1/39	1/12	2/3/4	79 ft
79F-065230	1/39	1/11	2/3/4	79 ft
79F-065250	1/39	6/61	2/3/4	79 ft
79F-065270	1/39	5/47	2/3/4	79 ft
79F-065300	1/51	1/12	2/3/4	79 ft

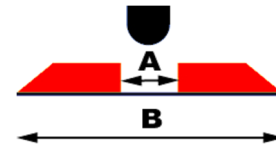

A 3,0 bis 3,5 mm / B 12 mm
A 4,0 bis 8,0 mm / B 15 mm

A&Max Fix Creasing Matrix

High quality creasing matrix made of plastic, film base

Item no.	Depth (in.)	Width (in.)	Locator pt.	Packed by
79F-065320	1/39	1/8	2/3/4	79 ft
79F-065350	1/39	4/29	2/3/4	79 ft
79F-065400	1/39	3/19	2/3/4	49 ft
79F-065450	1/39	14/79	2/3/4	49 ft
79F-065500	1/39	12/61	2/3/4	49 ft
79F-065600	1/39	13/55	2/3/4	49 ft
79F-065700	1/39	8/29	2/3/4	49 ft
79F-065800	1/39	23/73	2/3/4	49 ft
79F-070130	1/36	2/39	2/3/4	79 ft
79F-070140	1/36	1/18	2/3/4	79 ft
79F-070150	1/36	1/17	2/3/4	79 ft
79F-070160	1/36	1/16	2/3/4	79 ft
79F-070170	1/36	1/15	2/3/4	79 ft
79F-070190	1/36	3/40	2/3/4	79 ft
79F-070210	1/36	1/12	2/3/4	79 ft
79F-070230	1/36	1/11	2/3/4	79 ft
79F-070250	1/36	6/61	2/3/4	79 ft
79F-070270	1/36	5/47	2/3/4	79 ft
79F-070300	1/36	2/17	2/3/4	79 ft
79F-070320	1/36	1/8	2/3/4	49 ft
79F-070350	1/36	4/29	2/3/4	59 ft
79F-070400	1/36	3/19	2/3/4	49 ft
79F-070400.46	1/36	3/19	4/6	49 ft
79F-070450	1/36	14/79	2/3/4	49 ft
79F-070500	1/36	12/61	2/3/4	49 ft
79F-070500.46	1/36	12/61	4/6	49 ft
79F-070600	1/36	13/55	2/3/4	49 ft
79F-070800	1/36	23/73	2/3/4	49 ft
79F-080150	1/32	1/17	2/3/4	79 ft
79F-080160	1/32	1/16	2/3/4	79 ft
79F-080170	1/32	1/15	2/3/4	79 ft
79F-080190	1/32	3/40	2/3/4	79 ft
79F-080210	1/32	1/12	2/3/4	79 ft
79F-080230	1/32	1/11	2/3/4	79 ft
79F-080250	1/32	6/61	2/3/4	79 ft
79F-080270	1/32	5/47	2/3/4	79 ft
79F-080270.46	1/32	5/47	4/6	79 ft
79F-080280	1/32	1/9	2/3/4	79 ft
79F-080300	1/32	2/17	2/3/4	79 ft
79F-080300.46	1/32	2/17	4/6	79 ft
79F-080300.8	1/32	2/17	8	59 ft
79F-080320	1/32	1/8	2/3/4	59 ft
79F-080350	1/32	4/29	2/3/4	59 ft
79F-080400	1/32	3/19	2/3/4	49 ft
79F-080400.68	1/32	3/19	6/8	49 ft
79F-080400.8	1/32	3/19	8	49 ft
79F-080450	1/32	14/79	2/3/4	49 ft
79F-080450.46	1/32	14/79	4/6	49 ft
79F-080500	1/32	12/61	2/3/4	49 ft
79F-080500.46	1/32	12/61	2/3/4	49 ft
79F-080500.68	1/32	12/61	6/8	49 ft
79F-080500.8	1/32	12/61	8	49 ft

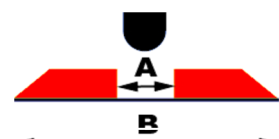

A 1,9 bis 3,0 mm / B 8,75 mm
A 3,2 bis 3,5 mm / B 12 mm
A 4,0 bis 8,0 mm / B 15 mm

Further sizes upon
request

A&Max Fix Creasing Matrix

High quality creasing matrix made of plastic, film base

Item no.	Depth (in.)	Width (in.)	Locator pt.	Packed by
79F-080600	1/32	13/55	2/3/4	49 ft
79F-080600.68	1/32	13/55	6/8	49 ft
79F-080600.8	1/32	13/55	8	49 ft
79F-080700	1/32	8/29	2/3/4	49 ft
79F-080800	1/32	8/29	2/3/4	49 ft
79F-100190	3/76	3/40	2/3/4	79 ft
79F-100210	3/76	1/12	2/3/4	79 ft
79F-100230	3/76	1/11	2/3/4	79 ft
79F-100250	3/76	6/61	2/3/4	79 ft
79F-100270	3/76	5/47	2/3/4	79 ft
79F-100300	3/76	2/17	2/3/4	79 ft
79F-100320	3/76	1/8	2/3/4	59 ft
79F-100320.46	3/76	1/8	4/6	59 ft
79F-100350	3/76	4/29	2/3/4	59 ft
79F-100350.46	3/76	4/29	4/6	59 ft
79F-100400	3/76	3/19	2/3/4	49 ft
79F-100400.46	3/76	3/19	4/6	49 ft
79F-100450	3/76	14/79	2/3/4	49 ft
79F-100450.46	3/76	14/79	4/6	49 ft
79F-100450.68	3/76	14/79	6/8	49 ft
79F-100500	3/76	12/61	2/3/4	49 ft
79F-100500.46	3/76	12/61	4/6	49 ft
79F-100500.68	3/76	12/61	6/8	49 ft
79F-100600	3/76	13/55	2/3/4	49 ft
79F-100600.46	3/76	13/55	4/6	49 ft
79F-100600.68	3/76	13/55	6/8	49 ft
79F-100600.8	3/76	13/55	8	49 ft
79F-100700	3/76	8/29	2/3/4	49 ft
79F-100700.8	3/76	8/29	8	49 ft
79F-100800	3/76	23/73	2/3/4	49 ft
79F-100800.46	3/76	23/73	4/6	49 ft
79F-120300	1/21	2/17	2/3/4	59 ft
79F-120300.46	1/21	2/17	4/6	59 ft
79F-120320	1/21	1/8	2/3/4	59 ft
79F-120350	1/21	4/29	2/3/4	59 ft
79F-120350.46	1/21	4/29	4/6	59 ft
79F-120400	1/21	3/19	2/3/4	49 ft
79F-120400.46	1/21	3/19	4/6	49 ft
79F-120400.68	1/21	3/19	6/8	49 ft
79F-120450	1/21	14/79	2/3/4	49 ft
79F-120450.68	1/21	14/79	6/8	49 ft
79F-120500	1/21	12/61	2/3/4	49 ft
79F-120500.46	1/21	12/61	4/6	49 ft
79F-120500.68	1/21	12/61	6/8	49 ft
79F-120600	1/21	13/55	2/3/4	49 ft
79F-120600.46	1/21	13/55	4/6	49 ft
79F-120600.8	1/21	13/55	8	49 ft
79F-120700	1/21	8/29	2/3/4	49 ft
79F-120800	1/21	23/73	2/3/4	49 ft

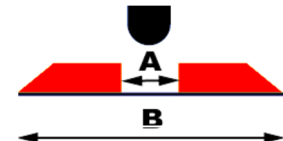

A 1,9 bis 3,0 mm / B 8,75 mm
A 3,2 bis 3,5 mm / B 12 mm
A 4,0 bis 8,0 mm / B 15 mm

Further sizes upon
request

A&Max Fix Creasing Matrix

High quality creasing matrix made of plastic, film base

Item no.	Depth (in.)	Width (in.)	Locator pt.	Packed by
79F-140300	1/18	2/17	2/3/4	59 ft
79F-140320	1/18	1/8	2/3/4	59 ft
79F-140350	1/18	4/29	2/3/4	59 ft
79F-140350.46	1/18	4/29	4/6	59 ft
79F-140400	1/18	3/19	2/3/4	49 ft
79F-140450	1/18	14/79	2/3/4	49 ft
79F-140500	1/18	12/61	2/3/4	49 ft
79F-140600	1/18	13/55	2/3/4	49 ft
79F-140600.68	1/18	13/55	6/8	49 ft
79F-140600.8	1/18	13/55	8	49 ft
79F-140700	1/18	8/29	2/3/4	49 ft
79F-140700.68	1/18	8/29	6/8	49 ft
79F-140800	1/18	23/73	2/3/4	49 ft
79F-140800.68	1/18	23/73	6/8	49 ft
79F-150500	1/17	12/61	2/3/4	49 ft
79F-160300	1/16	2/17	2/3/4	59 ft
79F-160320	1/16	1/8	2/3/4	59 ft
79F-160350	1/16	4/29	2/3/4	59 ft
79F-160400	1/16	3/19	2/3/4	49 ft
79F-160450	1/16	14/79	2/3/4	49 ft
79F-160500	1/16	12/61	2/3/4	49 ft
79F-160500.68	1/16	12/61	6/8	49 ft
79F-160600	1/16	13/55	2/3/4	49 ft
79F-160600.68	1/16	13/55	6/8	49 ft
79F-160700	1/16	8/29	2/3/4	49 ft
79F-160700.68	1/16	8/29	6/8	49 ft
79F-160800	1/16	23/73	2/3/4	49 ft
79F-160800.46	1/16	23/73	4/6	49 ft
79F-160800.68	1/16	23/73	6/8	49 ft

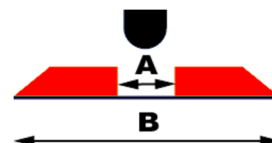

A 1,9 bis 3,0 mm / B 8,75 mm
A 3,2 bis 3,5 mm / B 12 mm
A 4,0 bis 8,0 mm / B 15 mm

A&Max Fix Multcrease Creasing Matrix

High quality creasing matrix made of plastic, film base

Item no.	Depth (in.)	Width (in.)	Locator pt.	Gap	Packed by
79F-MC-040100300	1/63	3/76	2/3/4	2/17	59 ft
79F-MC-040100475	1/63	3/76	2/3/4	3/16	59 ft
79F-MC-040120400	1/63	1/21	2/3/4	3/19	59 ft
79F-MC-040130350	1/63	2/39	2/3/4	4/29	59 ft
79F-MC-040130400	1/63	2/39	2/3/4	3/19	59 ft
79F-MC-040130500	1/63	2/39	2/3/4	12/61	59 ft
79F-MC-040130635	1/63	2/39	2/3/4	1/4	59 ft
79F-MC-045130350	1/56	2/39	2/3/4	4/29	59 ft
79F-MC-045130400	1/56	2/39	2/3/4	3/19	59 ft
79F-MC-045130500	1/56	2/39	2/3/4	12/61	59 ft
79F-MC-050100300	1/51	3/76	2/3/4	2/17	59 ft
79F-MC-050100475	1/51	3/76	2/3/4	3/16	59 ft
79F-MC-050130350	1/51	2/39	2/3/4	4/29	59 ft
79F-MC-050130400	1/51	2/39	2/3/4	3/19	59 ft
79F-MC-050130500	1/51	2/39	2/3/4	12/61	59 ft
79F-MC-050130635	1/51	2/39	2/3/4	1/4	59 ft
79F-MC-050150635	1/51	1/17	2/3/4	1/4	59 ft



Further sizes upon
request

A&Max Fix S Creasing Matrix

High quality creasing matrix made of plastic, film base.
Extra narrow 3 mm width instead of 6 mm

Item no.	Depth (in.)	Width (in.)	Locator pt.	Packed by
79F-S030050	1/85	1/51	2/3/4	79 ft
79F-S030060	1/85	2/85	2/3/4	79 ft
79F-S030080	1/85	1/32	2/3/4	79 ft
79F-S030100	1/85	3/76	2/3/4	79 ft
79F-S030120	1/85	1/21	2/3/4	79 ft
79F-S030130	1/85	2/39	2/3/4	79 ft
79F-S030140	1/85	1/18	2/3/4	79 ft
79F-S030150	1/85	1/17	2/3/4	79 ft
79F-S030170	1/85	1/15	2/3/4	79 ft
79F-S040050	1/63	1/51	2/3/4	79 ft
79F-S040060	1/63	2/85	2/3/4	79 ft
79F-S040080	1/63	1/32	2/3/4	79 ft
79F-S040100	1/63	3/76	2/3/4	79 ft
79F-S040120	1/63	1/21	2/3/4	79 ft
79F-S040130	1/63	2/39	2/3/4	79 ft
79F-S040140	1/63	1/18	2/3/4	79 ft
79F-S040150	1/63	1/17	2/3/4	79 ft
79F-S040160	1/63	1/16	2/3/4	79 ft
79F-S040170	1/63	1/15	2/3/4	79 ft
79F-S045050	1/56	1/51	2/3/4	79 ft
79F-S045080	1/56	1/32	2/3/4	79 ft
79F-S045120	1/56	1/21	2/3/4	79 ft
79F-S045140	1/56	1/18	2/3/4	79 ft
79F-S045150	1/56	1/17	2/3/4	79 ft
79F-S050080	1/51	1/32	2/3/4	79 ft
79F-S050100	1/51	3/76	2/3/4	79 ft
79F-S050120	1/51	1/21	2/3/4	79 ft
79F-S050130	1/51	2/39	2/3/4	79 ft
79F-S050140	1/51	1/18	2/3/4	79 ft
79F-S050150	1/51	1/17	2/3/4	79 ft
79F-S050160	1/51	1/16	2/3/4	79 ft
79F-S050170	1/51	1/15	2/3/4	79 ft
79F-S055130	1/46	2/39	2/3/4	79 ft
79F-S055140	1/46	1/18	2/3/4	79 ft
79F-S055150	1/46	1/17	2/3/4	79 ft
79F-S055160	1/46	1/16	2/3/4	79 ft
79F-S055170	1/46	1/15	2/3/4	79 ft
79F-S060150	2/85	1/17	2/3/4	79 ft
79F-S060160	2/85	1/16	2/3/4	79 ft
79F-S060170	2/85	1/15	2/3/4	79 ft
79F-S060190	2/85	3/40	2/3/4	79 ft

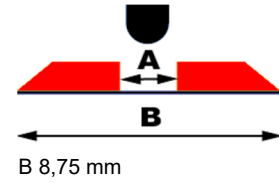

Further sizes upon
request

A&Max Fix Offcenter Creasing Matrix

Off-Center High quality creasing matrix made of plastic, film base. For narrow distances between rules.

Item no.	Depth (in.)	Width (in.)	Locator pt.	Packed by
79F-OC-030060	1/85	2/85	2/3/4	79 ft
79F-OC-030080	1/85	1/32	2/3/4	79 ft
79F-OC-030100	1/85	3/76	2/3/4	79 ft
79F-OC-030110	1/85	1/23	2/3/4	79 ft
79F-OC-030120	1/85	1/21	2/3/4	79 ft
79F-OC-030130	1/85	2/39	2/3/4	79 ft
79F-OC-030140	1/85	1/18	2/3/4	79 ft
79F-OC-030150	1/85	1/17	2/3/4	79 ft
79F-OC-030160	1/85	1/16	2/3/4	79 ft
79F-OC-030170	1/85	1/15	2/3/4	79 ft
79F-OC-030190	1/85	3/40	2/3/4	79 ft
79F-OC-040060	1/63	2/85	2/3/4	79 ft
79F-OC-040080	1/63	1/32	2/3/4	79 ft
79F-OC-040100	1/63	3/76	2/3/4	79 ft
79F-OC-040110	1/63	1/23	2/3/4	79 ft
79F-OC-040120	1/63	1/21	2/3/4	79 ft
79F-OC-040130	1/63	2/39	2/3/4	79 ft
79F-OC-040140	1/63	1/18	2/3/4	79 ft
79F-OC-040150	1/63	1/17	2/3/4	79 ft
79F-OC-040160	1/63	1/16	2/3/4	79 ft
79F-OC-040170	1/63	1/15	2/3/4	79 ft
79F-OC-040190	1/63	3/40	2/3/4	79 ft
79F-OC-045080	1/56	1/32	2/3/4	79 ft
79F-OC-045100	1/56	3/76	2/3/4	79 ft
79F-OC-045110	1/56	1/23	2/3/4	79 ft
79F-OC-045120	1/56	1/21	2/3/4	79 ft
79F-OC-045130	1/56	2/39	2/3/4	79 ft
79F-OC-045140	1/56	1/18	2/3/4	79 ft
79F-OC-045150	1/56	1/17	2/3/4	79 ft
79F-OC-045160	1/56	1/16	2/3/4	79 ft
79F-OC-045170	1/56	1/15	2/3/4	79 ft
79F-OC-045190	1/56	3/40	2/3/4	79 ft
79F-OC-050080	1/51	1/32	2/3/4	79 ft
79F-OC-050100	1/51	3/76	2/3/4	79 ft
79F-OC-050110	1/51	1/23	2/3/4	79 ft
79F-OC-050120	1/51	1/21	2/3/4	79 ft
79F-OC-050130	1/51	2/39	2/3/4	79 ft
79F-OC-050140	1/51	1/18	2/3/4	79 ft
79F-OC-050150	1/51	1/17	2/3/4	79 ft
79F-OC-050160	1/51	1/16	2/3/4	79 ft
79F-OC-050170	1/51	1/15	2/3/4	79 ft
79F-OC-050190	1/51	3/40	2/3/4	79 ft
79F-OC-050210	1/51	1/12	2/3/4	79 ft
79F-OC-050230	1/51	1/11	2/3/4	79 ft



Further sizes upon
request

A&Max Fix Offcenter Creasing Matrix

Off-Center High quality creasing matrix made of plastic, film base. For narrow distances between rules.

Item no.	Depth (in.)	Width (in.)	Locator pt.	Packed by
79F-OC-055080	1/46	1/32	2/3/4	79 ft
79F-OC-055120	1/46	1/21	2/3/4	79 ft
79F-OC-055130	1/46	2/39	2/3/4	79 ft
79F-OC-055140	1/46	1/18	2/3/4	79 ft
79F-OC-055150	1/46	1/17	2/3/4	79 ft
79F-OC-055160	1/46	1/16	2/3/4	79 ft
79F-OC-055170	1/46	1/15	2/3/4	79 ft
79F-OC-055190	1/46	3/40	2/3/4	79 ft
79F-OC-055210	1/46	1/12	2/3/4	79 ft
79F-OC-055230	1/46	1/11	2/3/4	79 ft
79F-OC-060100	2/85	3/76	2/3/4	79 ft
79F-OC-060130	2/85	2/39	2/3/4	79 ft
79F-OC-060140	2/85	1/18	2/3/4	79 ft
79F-OC-060150	2/85	1/17	2/3/4	79 ft
79F-OC-060160	2/85	1/16	2/3/4	79 ft
79F-OC-060170	2/85	1/15	2/3/4	79 ft
79F-OC-060190	2/85	3/40	2/3/4	79 ft
79F-OC-060210	2/85	1/12	2/3/4	79 ft
79F-OC-060230	2/85	1/11	2/3/4	79 ft
79F-OC-060250	2/85	6/61	2/3/4	79 ft
79F-OC-060270	2/85	5/47	2/3/4	79 ft
79F-OC-060300	2/85	2/17	2/3/4	79 ft
79F-OC-060400	2/85	3/19	2/3/4	49 ft
79F-OC-065160	1/39	1/16	2/3/4	79 ft
79F-OC-065190	1/39	3/40	2/3/4	79 ft
79F-OC-065210	1/39	1/12	2/3/4	79 ft
79F-OC-070130	1/36	2/39	2/3/4	79 ft
79F-OC-070140	1/36	1/18	2/3/4	79 ft
79F-OC-070150	1/36	1/17	2/3/4	79 ft
79F-OC-070170	1/36	1/15	2/3/4	79 ft
79F-OC-070190	1/36	3/40	2/3/4	79 ft
79F-OC-070210	1/36	1/12	2/3/4	79 ft
79F-OC-070230	1/36	1/11	2/3/4	79 ft
79F-OC-070250	1/36	6/61	2/3/4	79 ft
79F-OC-070270	1/36	5/47	2/3/4	79 ft
79F-OC-070300	1/36	2/17	2/3/4	79 ft
79F-OC-080150	1/32	1/17	2/3/4	79 ft
79F-OC-080160	1/32	1/16	2/3/4	79 ft
79F-OC-080170	1/32	1/15	2/3/4	79 ft
79F-OC-080190	1/32	3/40	2/3/4	79 ft
79F-OC-080210	1/32	1/12	2/3/4	79 ft
79F-OC-080230	1/32	1/11	2/3/4	79 ft
79F-OC-080250	1/32	6/61	2/3/4	79 ft
79F-OC-080270	1/32	5/47	2/3/4	79 ft
79F-OC-080300	1/32	2/17	2/3/4	79 ft
79F-OC-080320	1/32	1/8	2/3/4	59 ft
79F-OC-080350	1/32	4/29	2/3/4	59 ft
79F-OC-080400	1/32	3/19	2/3/4	49 ft
79F-OC-080450	1/32	14/79	2/3/4	49 ft

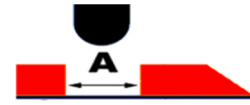

Further sizes upon request

A&Max Fix Offcenter Creasing Matrix

Off-Center High quality creasing matrix made of plastic, film base. For narrow distances between rules.

Item no.	Depth (in.)	Width (in.)	Locator pt.	Packed by
79F-OC-100230	3/76	1/11	2/3/4	79 ft
79F-OC-100270	3/76	5/47	2/3/4	79 ft
79F-OC-100300	3/76	2/17	2/3/4	79 ft
79F-OC-100350	3/76	4/29	2/3/4	59 ft
79F-OC-100400	3/76	3/19	2/3/4	49 ft
79F-OC-100500	3/76	12/61	2/3/4	49 ft
79F-OC-100500.46	3/76	12/61	4/6	49 ft
79F-OC-100600	3/76	13/55	2/3/4	49 ft
79F-OC-120320	1/21	1/8	2/3/4	59 ft
79F-OC-120350	1/21	4/29	2/3/4	59 ft
79F-OC-120400	1/21	3/19	2/3/4	49 ft
79F-OC-120450	1/21	14/79	2/3/4	49 ft
79F-OC-120600	1/21	13/55	2/3/4	49 ft
79F-OC-120800	1/21	23/73	2/3/4	49 ft
79F-OC-140320	1/18	1/8	2/3/4	59 ft
79F-OC-140500	1/18	12/61	2/3/4	49 ft
79F-OC-160400	1/16	3/19	2/3/4	59 ft
79F-OC-160500	1/16	12/61	2/3/4	49 ft



Further sizes upon request

Accessories for creasing matrix

Item no.	Description
NCZ-003	A&Max Cutter for creasing matrix
NCZ-003.WZ	Cutting knife for A&Max Cutter
NCZ-004	A&Max Matrix Chamfering Cutter
NCZ-004.WZ	Cutting knife for A&Max Matrix Chamfering Cutter
NCZ-005	Scissors for Creasing matrix
NCZ-005.WZ	Cutting knives for Scissors NCZ-005 (Set of 10)



Make Ready Stripe, made of paper

Profitape

Item no.	Thickness	Width	Length	Packed by
70-PT-30.030	30 µm	2/17 in	115 ft	40 Reels
70-PT-30.060	30 µm	13/55 in	115 ft	25 Reels
70-PT-30.120	30 µm	43/91 in	115 ft	12 Reels
70-PT-30.200	30 µm	37/47 in	115 ft	7 Reels
70-PT-30.300	30 µm	1 2/11 in	115 ft	5 Reels
70-PT-50.030	50 µm	2/17 in	82 ft	40 Reels
70-PT-50.060	50 µm	13/55 in	82 ft	25 Reels
70-PT-50.120	50 µm	43/91 in	82 ft	12 Reels
70-PT-50.200	50 µm	37/47 in	82 ft	7 Reels
70-PT-50.300	50 µm	1 2/11 in	82 ft	5 Reels
70-PT-80.030	80 µm	2/17 in	59 ft	40 Reels
70-PT-80.060	80 µm	13/55 in	59 ft	25 Reels
70-PT-80.120	80 µm	43/91 in	59 ft	12 Reels
70-PT-80.200	80 µm	37/47 in	59 ft	7 Reels
70-PT-80.300	80 µm	1 2/11 in	59 ft	5 Reels



Make Ready Stripe, made of steel

Sticky Tape

Item no.	Thickness	Width	Length	Packed by
70-00-009	30 µm	8/29 in	33 ft	5 Reels
70-00-010	40 µm	8/29 in	33 ft	5 Reels
70-00-011	100 µm	8/29 in	33 ft	5 Reels



A&M Platecleaner

Cutting plate cleaner

Item no.	Packed by
70-00-032.5	Can 1,3 gal
70-00-032.10	Can 2,6 gal
70-00-032.30	Can 7,9 gal



Counter Plates

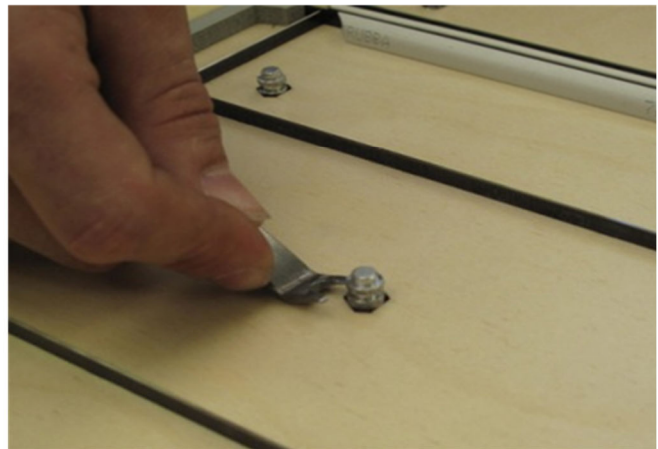
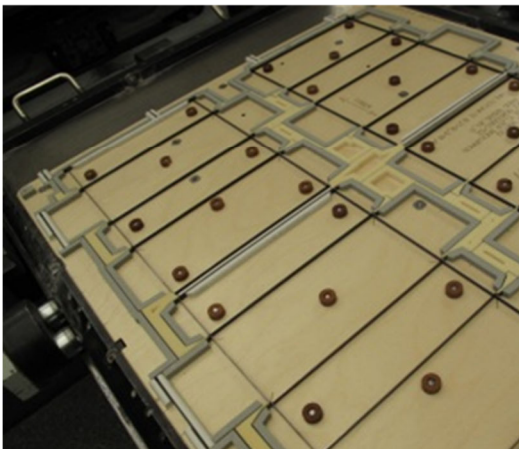
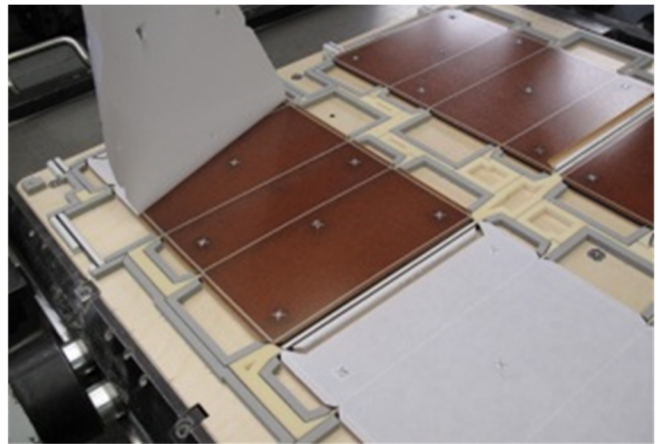
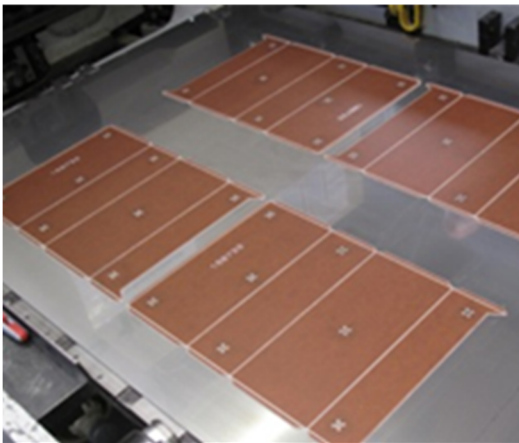

Perfect in die-supplies

Laminated Paper Sheet XXL

Laminated Paper Sheet XXL with two sided fibre reinforcement

Item no.	Thickness	Length	Width	Packed by
71-10-030	1/85 in	3,5 ft	3,5 ft	5 Sheets
71-10-035	1/73 in	3,5 ft	3,5 ft	5 Sheets
71-10-040	1/63 in	3,5 ft	3,5 ft	5 Sheets
71-10-045	1/56 in	3,5 ft	3,5 ft	5 Sheets
71-10-050	1/51 in	3,5 ft	3,5 ft	5 Sheets
71-10-055	1/46 in	3,5 ft	3,5 ft	5 Sheets
71-10-060	2/85 in	3,5 ft	3,5 ft	5 Sheets
71-10-065	1/39 in	3,5 ft	3,5 ft	5 Sheets
71-10-070	1/36 in	3,5 ft	3,5 ft	5 Sheets
71-10-075	1/34 in	3,5 ft	3,5 ft	5 Sheets
71-10-080	1/32 in	3,5 ft	3,5 ft	5 Sheets
71-10-085	1/30 in	3,5 ft	3,5 ft	5 Sheets
71-10-090	1/28 in	3,5 ft	3,5 ft	5 Sheets
71-10-100	3/76 in	3,5 ft	3,5 ft	5 Sheets
71-10-110	1/23 in	3,5 ft	3,5 ft	5 Sheets
71-10-120	1/21 in	3,5 ft	3,5 ft	5 Sheets
71-10-130	2/39 in	3,5 ft	3,5 ft	5 Sheets
71-10-150	1/17 in	3,5 ft	3,5 ft	5 Sheets
71-10-200	3/38 in	3,5 ft	3,5 ft	5 Sheets



Laminated Paper Sheet XXL 2x2

Laminated Paper Sheet XXL 2x2 with two sided double fibre reinforcement

Item no.	Thickness	Length	Width	Packed by
71-30-045	1/56 in	3,5 ft	3,5 ft	5 Sheets
71-30-050	1/51 in	3,5 ft	3,5 ft	5 Sheets
71-30-055	1/46 in	3,5 ft	3,5 ft	5 Sheets
71-30-060	2/85 in	3,5 ft	3,5 ft	5 Sheets
71-30-065	1/39 in	3,5 ft	3,5 ft	5 Sheets
71-30-070	1/36 in	3,5 ft	3,5 ft	5 Sheets
71-30-075	1/34 in	3,5 ft	3,5 ft	5 Sheets
71-30-080	1/32 in	3,5 ft	3,5 ft	5 Sheets
71-30-085	1/30 in	3,5 ft	3,5 ft	5 Sheets
71-30-090	1/28 in	3,5 ft	3,5 ft	5 Sheets
71-30-095	3/80 in	3,5 ft	3,5 ft	5 Sheets
71-30-100	3/76 in	3,5 ft	3,5 ft	5 Sheets
71-10-SK	Selfadhesive backing for Pertinax			5 Sheets

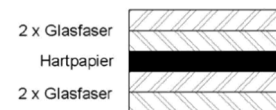

Accessory for counter plates

Item no.	Description	Packed by
70-00-019	Position Pins - cylindric, made of steel, grinded, 12/61 x 37/47 in.	100 Pcs
70-00-023	Position Pins, made of aluminium, Diam.= 23/73 x 21/97 in, length= 43/52 in	100 Pcs
70-00-024	Position Pins, made of plastic, Diam.= 23/73 x 21/97 in, length= 43/52 in	100 Pcs
70-00-020	Rings of Polyurethane, suitable to item.-no.70-00-019, thickness = 8/29 in, inner diam. = 14/79 in, outer diam. = 13/22 in	100 Pcs
70-00-026	Rings of Polyurethane, suitable to item-no. 70-00-023, thickness = 8/29 in, inner diam. = 13/44 in, outer diam. = 13/22 in	100 Pcs
60-00-001	Self adhesive film in reels for laminating laminated paper sheets 3,5 ft x 164 ft	1 Reel

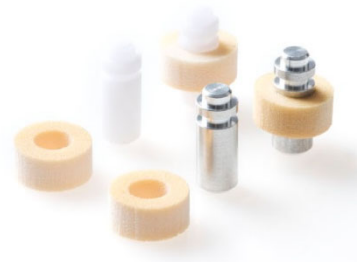

VHM- Millers

Single cutter, cylindrical

Item no.	Head Ø	Shaft Ø	Total length	Packed by
76-10-300.40.080	1/32 in	2/17 in	1 23/40 in	10
76-10-300.40.090	1/28 in	2/17 in	1 23/40 in	10
76-10-300.40.100	3/76 in	2/17 in	1 23/40 in	10
76-10-300.40.110	1/23 in	2/17 in	1 23/40 in	10
76-10-300.40.120	1/21 in	2/17 in	1 23/40 in	10
76-10-300.40.130	2/39 in	2/17 in	1 23/40 in	10
76-10-300.40.140	1/18 in	2/17 in	1 23/40 in	10
76-10-300.40.150	1/17 in	2/17 in	1 23/40 in	10
76-10-300.40.160	1/16 in	2/17 in	1 23/40 in	10
76-10-300.40.170	1/15 in	2/17 in	1 23/40 in	10
76-10-300.40.180	1/14 in	2/17 in	1 23/40 in	10
76-10-300.40.190	3/40 in	2/17 in	1 23/40 in	10
76-10-300.40.200	3/38 in	2/17 in	1 23/40 in	10
76-10-300.40.210	1/12 in	2/17 in	1 23/40 in	10
76-10-300.40.220	2/23 in	2/17 in	1 23/40 in	10
76-10-300.40.230	1/11 in	2/17 in	1 23/40 in	10
76-10-300.40.240	5/53 in	2/17 in	1 23/40 in	10
76-10-300.40.250	6/61 in	2/17 in	1 23/40 in	10
76-10-300.40.260	9/88 in	2/17 in	1 23/40 in	10
76-10-300.40.270	5/47 in	2/17 in	1 23/40 in	10
76-10-300.40.280	1/9 in	2/17 in	1 23/40 in	10
76-10-300.40.290	4/35 in	2/17 in	1 23/40 in	10
76-10-300.40.300	2/17 in	2/17 in	1 23/40 in	10



VHM-(peripheral) millers

Double cutter

Item no.	Angle °	Head Ø	Shaft Ø	Total length
76-12-300.40.050.120	120°	12/61 in	2/17 in	1 23/40 in
76-12-300.40.090.160	160°	17/48 in	2/17 in	1 23/40 in
76-12-300.40.090.170	170°	17/48 in	2/17 in	1 23/40 in



VHM-(Position hole) Millers

Double cutter

Item no.	Angle °	Head Ø	Shaft Ø	Total length
76-12-300.40.050	180°	12/61 in	2/17 in	1 23/40 in
76-12-300.40.055	180°	21/97 in	2/17 in	1 23/40 in



VHM-(scan) millers

Quadruple cutter

Item no.	Angle °	Head Ø	Shaft Ø	Total length
76-14-300.40.090	180°	17/48 in	2/17 in	1 23/40 in



Plotter Accessories

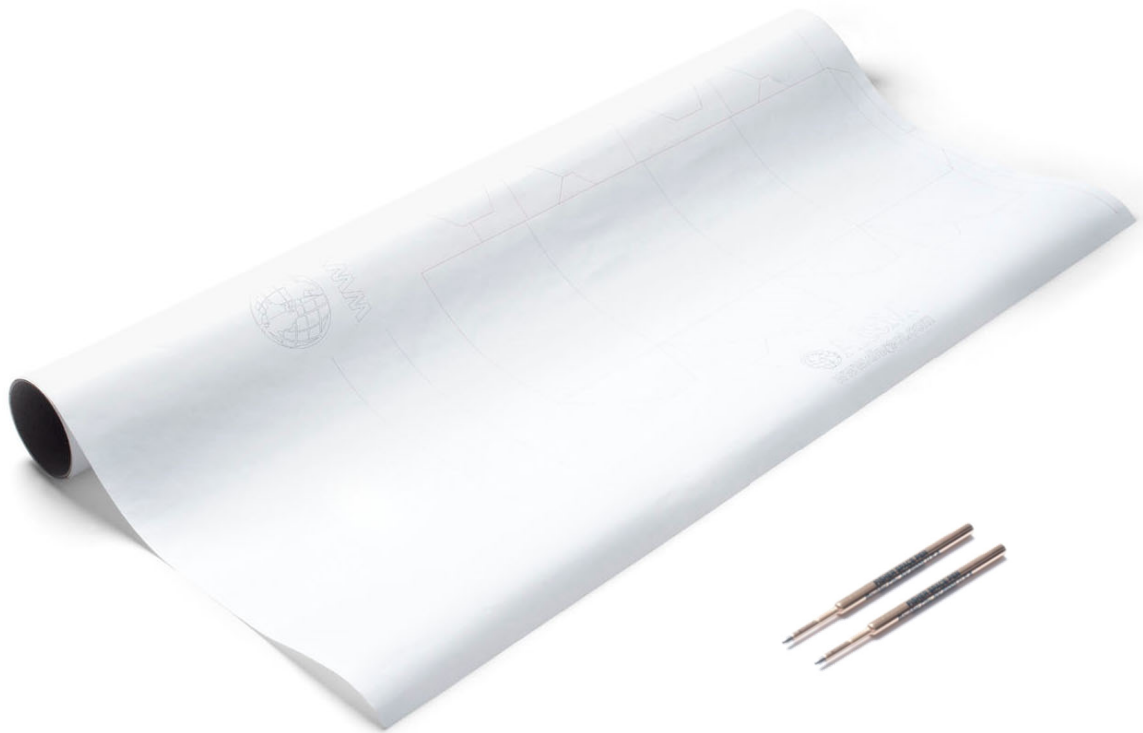

Perfect in die-supplies

Make ready- and drawing films

Made of polyester, two-sided matt

Item no.	Thickness	Length	Width	Packed by
60-PE-70/914	70µm	164 ft	3,0 ft	1 Reel
60-PE-70/1120	70µm	164 ft	3,7 ft	1 Reel
60-PE-70/1220	70µm	164 ft	4,0 ft	1 Reel
60-PE-70/1350	70µm	164 ft	4,4 ft	1 Reel
60-PE-90/914	90µm	164 ft	3,0 ft	1 Reel
60-PE-90/1120	90µm	164 ft	3,7 ft	1 Reel
60-PE-90/1220	90µm	164 ft	4,0 ft	1 Reel
60-PE-90/1350	90µm	164 ft	4,4 ft	1 Reel
60-PE-140/914	140µm	164 ft	3,0 ft	1 Reel
60-PE-140/1220	140µm	164 ft	4,0 ft	1 Reel



Make ready- and drawing films PRO

Made of polyester, two-sided matt, special coating for Inkjet-plotters

Item no.	Thickness	Length	Width	Packed by
60-PE-70/1220.PRO	70µm	164 ft	4,0 ft	1 Reel
60-PE-70/1500.PRO	70µm	164 ft	4,9 ft	1 Reel



Make ready- and drawing films

Made of polypropylene, white opaque, two-sided matt

Item no.	Thickness	Length	Width	Packed by
60-PP-80/1200	80µm	164 ft	4,0 ft	1 Reel



Make ready-paper

Calibratet

Item no.	Thickness	Length	Width	Packed by
60-PA-100/1200	100µm	164 ft	3,9 ft	1 Reel
60-PA-100/1350	100µm	164 ft	4,4 ft	1 Reel



Triplex Fims

Paper / Foil / Paper

Item no.	Thickness	Length	Width	Packed by
60-TP-1120	110µm	164 ft	3,7 ft	1 Reel
60-TP-1200	110µm	164 ft	3,9 ft	1 Reel
60-TP-1350	110µm	164 ft	4,4 ft	1 Reel



Carbon Paper (black)

Item no.	Grammage	Length	Width	Packed by
60-00-002	0,7 oz/yd ²	328 ft	2,4 ft	1 Reel



Plotter cutting mat

Item no.	Thickness	Length	Width	Packed by
60-00-008	2/17 in	According to requirement	4,9 ft	According to size



Space pen

Item no.	Pen ø	Length	Mine	Colour	Packed by
60-00-003.BL	17/90 in	3 1/2 in	Thick	Blue	12 Pcs
60-00-003.SZ	17/90 in	3 1/2 in	Thick	Black	12 Pcs
60-00-003.RT-1	17/90 in	3 1/2 in	Medium	Red	12 Pcs
60-00-003.GR-1	17/90 in	3 1/2 in	Medium	Green	12 Pcs
60-00-003.BL-1	17/90 in	3 1/2 in	Medium	Blue	12 Pcs
60-00.003.SZ-1	17/90 in	3 1/2 in	Medium	Black	12 Pcs



Plotter blades

For Lasercomb-Plotter

Item no.	Description	Packed by
65-10-001.HSS	HSS plotter blade for Lasercomb-Plotter 1 2/85 x 13/55 x 1/39 in	10 Pcs
65-10-001.TIN	HSS plotter blade TIN for Lasercomb-Plotter 1 2/85 x 13/55 x 1/39 in	10 Pcs
65-10-001.VHM	VHM plotter blade for Lasercomb-Plotter 1 2/85 x 13/55 x 1/39 in	10 Pcs
65-10-002.HSS	HSS plotter blade for Lasercomb-Plotter 17/18 x 13/55 x 1/39 in	10 Pcs
65-10-003.HSS	HSS plotter blade for Lasercomb-Plotter 1 7/8 x 23/73 x 3/76 in	10 Pcs
65-10-003.SS	Supersteell plotterblade for Lasercomb-Plotter 1 7/8 x 23/73 x 3/76 in	10 Pcs
65-10-004.HSS	HSS plotterblade for Lasercomb-Plotter 1 7/8 x 23/73 x 3/76 : 1/51 in	10 Pcs
65-10-004.SS	Supersteel plotterblade for Lasercomb-Plotter 1 7/8 x 23/73 x 3/76 : 1/51 in	10 Pcs
65-10-005.SS	Supersteell plotterblade for Lasercomb-Plotter 2 19/71 x 23/73 x 3/76 in	10 Pcs
65-10-006.HSS	HSS plotterblade for Lasercomb-Plotter 2 19/71 x 23/73 x 3/76 : 1/36 in	10 Pcs
65-10-006.SS	Supersteel plotterblade for Lasercomb-Plotter 2 19/71 x 23/73 x 3/76 : 1/36 in	10 Pcs



Plotter blades

For Aristo-Plotter

Item no.	Description	Packed by
65-13-001.VHM	Flat blade for Aristo Multihead 1	10 Pcs
65-13-002.VHM	Blade for foil and compact cardboard for Aristo Multihead 1	10 Pcs
65-13-003.VHM	Plotter blade for Aristo Multihead 1, cutting depth up to 12/61 in	10 Pcs
65-13-004.VHM	Plotter blade for Aristo Multihead 1 and oscillating cutting head, cutting depth up to 37/94 in	10 Pcs
65-13-005.VHM	Plotter blade for Aristo Multihead 1 and oscillating cutting head, cutting depth up to 13/22 in	10 Pcs



Nicking & Accesories



Perfect in die-supplies

A&M Grindy

High performance grinding discs (BA- quality)

Item no.	Thickness	ØInner (in.)	ØOuter	Packed by
55-35/6.9-002	1/127 in	13/55 : 17/48	1 17/45 in	25 Pcs
55-35/6.9-003	1/85 in	13/55 : 17/48	1 17/45 in	25 Pcs
55-35/6.9-004	1/63 in	13/55 : 17/48	1 17/45 in	25 Pcs
55-35/6.9-005	1/51 in	13/55 : 17/48	1 17/45 in	25 Pcs
55-35/6.9-006	3/127 in	13/55 : 17/48	1 17/45 in	25 Pcs
55-35/6.9-007	1/36 in	13/55 : 17/48	1 17/45 in	25 Pcs
55-35/6.9-008	1/32 in	13/55 : 17/48	1 17/45 in	25 Pcs
55-35/6.9-009	1/28 in	13/55 : 17/48	1 17/45 in	25 Pcs
55-35/6.9-010	3/76 in	13/55 : 17/48	1 17/45 in	25 Pcs
55-35/6.9-015	1/17 in	13/55 : 17/48	1 17/45 in	25 Pcs
55-35/6.9-020	3/38 in	13/55 : 17/48	1 17/45 in	25 Pcs
55-35/6.9-025	6/61 in	13/55 : 17/48	1 17/45 in	25 Pcs
55-35/6.9-030	2/17 in	13/55 : 17/48	1 17/45 in	25 Pcs

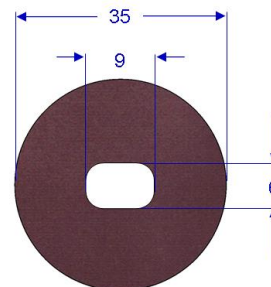

55-35/7-002	1/127 in	8/29 in	1 17/45 in	25 Pcs
55-35/7-003	1/85 in	8/29 in	1 17/45 in	25 Pcs
55-35/7-004	1/63 in	8/29 in	1 17/45 in	25 Pcs
55-35/7-005	1/51 in	8/29 in	1 17/45 in	25 Pcs
55-35/7-006	2/85 in	8/29 in	1 17/45 in	25 Pcs
55-35/7-007	1/36 in	8/29 in	1 17/45 in	25 Pcs
55-35/7-008	1/32 in	8/29 in	1 17/45 in	25 Pcs
55-35/7-009	1/28 in	8/29 in	1 17/45 in	25 Pcs
55-35/7-010	3/76 in	8/29 in	1 17/45 in	25 Pcs
55-35/7-015	1/17 in	8/29 in	1 17/45 in	25 Pcs
55-35/7-020	3/38 in	8/29 in	1 17/45 in	25 Pcs
55-35/7-025	6/61 in	8/29 in	1 17/45 in	25 Pcs
55-35/7-030	2/17 in	8/29 in	1 17/45 in	25 Pcs

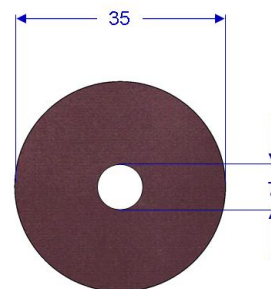

55-50/6-002	1/127 in	13/55 in	1 31/32 in	25 Pcs
55-50/6-003	1/85 in	13/55 in	1 31/32 in	25 Pcs
55-50/6-004	1/63 in	13/55 in	1 31/32 in	25 Pcs
55-50/6-005	1/51 in	13/55 in	1 31/32 in	25 Pcs
55-50/6-006	2/85 in	13/55 in	1 31/32 in	25 Pcs
55-50/6-007	1/36 in	13/55 in	1 31/32 in	25 Pcs
55-50/6-008	1/32 in	13/55 in	1 31/32 in	25 Pcs
55-50/6-009	1/28 in	13/55 in	1 31/32 in	25 Pcs
55-50/6-010	3/76 in	13/55 in	1 31/32 in	25 Pcs
55-50/6-015	1/17 in	13/55 in	1 31/32 in	25 Pcs
55-50/6-020	3/38 in	13/55 in	1 31/32 in	25 Pcs
55-50/6-025	6/61 in	13/55 in	1 31/32 in	25 Pcs
55-50/6-030	2/17 in	13/55 in	1 31/32 in	25 Pcs

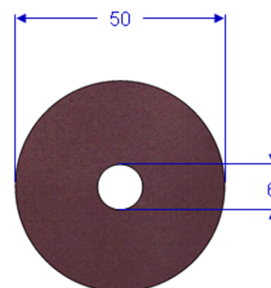

A&M Grindy

High performance grinding discs (BA- quality)

Item no.	Thickness	ØInner	ØOuter	Packed by
55-50/8-002	1/127 in	23/73 in	1 31/32 in	25 Pcs
55-50/8-003	1/85 in	23/73 in	1 31/32 in	25 Pcs
55-50/8-004	1/63 in	23/73 in	1 31/32 in	25 Pcs
55-50/8-005	1/51 in	23/73 in	1 31/32 in	25 Pcs
55-50/8-006	2/85 in	23/73 in	1 31/32 in	25 Pcs
55-50/8-007	1/36 in	23/73 in	1 31/32 in	25 Pcs
55-50/8-008	1/32 in	23/73 in	1 31/32 in	25 Pcs
55-50/8-009	1/28 in	23/73 in	1 31/32 in	25 Pcs
55-50/8-010	3/76 in	23/73 in	1 31/32 in	25 Pcs
55-50/8-015	1/17 in	23/73 in	1 31/32 in	25 Pcs
55-50/8-020	3/38 in	23/73 in	1 31/32 in	25 Pcs
55-50/8-025	6/61 in	23/73 in	1 31/32 in	25 Pcs
55-50/8-030	2/17 in	23/73 in	1 31/32 in	25 Pcs

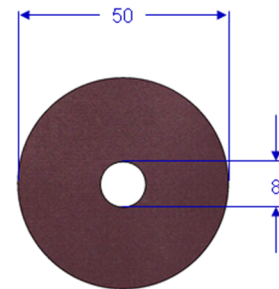

55-50/10-002	1/127 in	37/94 in	1 31/32 in	25 Pcs
55-50/10-003	1/85 in	37/94 in	1 31/32 in	25 Pcs
55-50/10-004	1/63 in	37/94 in	1 31/32 in	25 Pcs
55-50/10-005	1/51 in	37/94 in	1 31/32 in	25 Pcs
55-50/10-006	2/85 in	37/94 in	1 31/32 in	25 Pcs
55-50/10-007	1/36 in	37/94 in	1 31/32 in	25 Pcs
55-50/10-008	1/32 in	37/94 in	1 31/32 in	25 Pcs
55-50/10-009	1/28 in	37/94 in	1 31/32 in	25 Pcs
55-50/10-010	3/76 in	37/94 in	1 31/32 in	25 Pcs
55-50/10-015	1/17 in	37/94 in	1 31/32 in	25 Pcs
55-50/10-020	3/38 in	37/94 in	1 31/32 in	25 Pcs
55-50/10-025	6/61 in	37/94 in	1 31/32 in	25 Pcs
55-50/10-030	2/17 in	37/94 in	1 31/32 in	25 Pcs

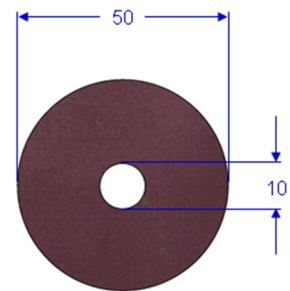

A&M Grindy Diamond

High performance grinding discs (diamond-quality)

Item no.	Thickness	ØInner	ØOuter	Packed by
55-35/7-003CBN	3/254 in	8/29 in	1 17/45 in	2 Pcs
55-50/7-004CBN	1/63 in	8/29 in	1 17/45 in	2 Pcs
55-35/7-005CBN	1/51 in	8/29 in	1 17/45 in	2 Pcs
55-35/7-006CBN	2/85 in	8/29 in	1 17/45 in	2 Pcs
55-35/7-007CBN	1/36 in	8/29 in	1 17/45 in	2 Pcs
55-35/7-008CBN	1/32 in	8/29 in	1 17/45 in	2 Pcs
55-35/7-009CBN	1/28 in	8/29 in	1 17/45 in	2 Pcs
55-35/7-010CBN	3/76 in	8/29 in	1 17/45 in	2 Pcs
55-35/7-012CBN	1/21 in	8/29 in	1 17/45 in	2 Pcs
55-35/7-015CBN	1/17 in	8/29 in	1 17/45 in	2 Pcs
55-35/7-020CBN	3/38 in	8/29 in	1 17/45 in	2 Pcs
55-35/7-025CBN	6/61 in	8/29 in	1 17/45 in	2 Pcs
55-50/8-003CBN	1/85 in	23/73 in	1 31/32 in	2 Pcs
55-50/8-004CBN	1/63 in	23/73 in	1 31/32 in	2 Pcs
55-50/8-005CBN	1/51 in	23/73 in	1 31/32 in	2 Pcs
55-50/8-006CBN	2/85 in	23/73 in	1 31/32 in	2 Pcs
55-50/8-007CBN	1/36 in	23/73 in	1 31/32 in	2 Pcs
55-50/8-008CBN	1/32 in	23/73 in	1 31/32 in	2 Pcs
55-50/8-009CBN	1/28 in	23/73 in	1 31/32 in	2 Pcs
55-50/8-010CBN	3/76 in	23/73 in	1 31/32 in	2 Pcs
55-50/8-012CBN	1/21 in	23/73 in	1 31/32 in	2 Pcs
55-50/8-015CBN	1/17 in	23/73 in	1 31/32 in	2 Pcs
55-50/8-020CBN	3/38 in	23/73 in	1 31/32 in	2 Pcs
55-50/8-025CBN	6/61 in	23/73 in	1 31/32 in	2 Pcs
55-50/8-030CBN	2/17 in	23/73 in	1 31/32 in	2 Pcs

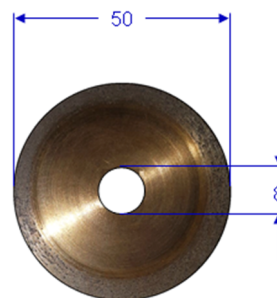
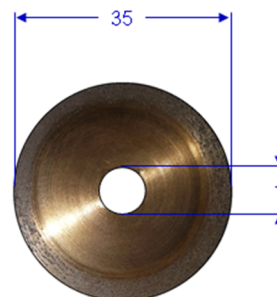

Nickgrinders

Item no.	Description
55-00-007.50/8	A&Max Grinder P, pneumatic, Discdiam. outside Ø: 1 31/32 in, inside Ø: 23/73 in, 35000 RpM, max. 90 psi
55-00-000.US	Nickgrinder NG2 elektric Discdiam. outside Ø: 1 17/45 in, inside Ø: 8/29 in, 18000 RpM, 120V, 5,5 lb



Stripper die-parts

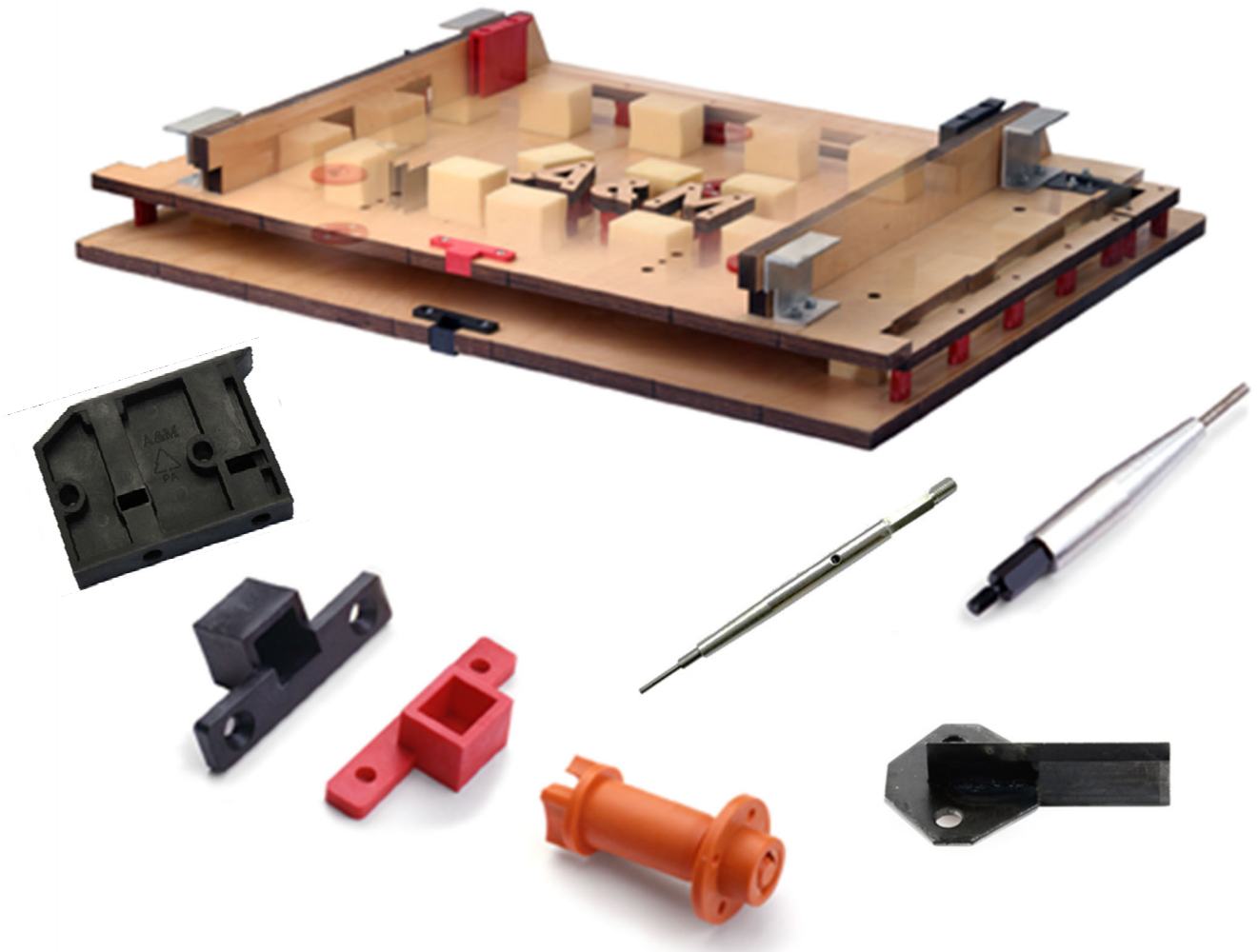

Perfect in die-supplies

Parts for stripper dies

Item no.	Description	Packed by
20-GE-001/20	Spacer, oval, best stability, body length = 37/47 in	400 Pcs
20-RT-001/23	Spacer, oval, best stability, body length = 48/53 in	400 Pcs
20-BL-001/23	Spacer, oval, RAL 5012, best stability, body length = 48/53 in	400 Pcs
20-SZ-001/23.1	Spacer, round, black, best Stability, body length = 48/53 in	500 Pcs
20-RT-001/25	Spacer, oval, best stability, body length = 62/63 in	400 Pcs
20-RT-001/28	Spacer, oval, best stability, body length = 1 4/39 in	400 Pcs
20-OR-001/30	Spacer, oval, best stability, body length = 1 2/11 in	400 Pcs
20-00-002	Centering Stop for upper Stripping board, black	100 Pcs
20-00-003	Centering Stop for female Stripping board, red	100 Pcs
20-SZ-015	Clamping block for male and female stripping die, black	100 Pcs
20-00-035	Clamping block for Bobst SP Maschine, blue	100 Pcs
20-00-036	Strengthening for Centerline 13/22 x 23/73 for 43/91 wood thickness	100 Pcs
20-00-037	Strengthening for Centerline 13/22 x 23/73 for 13/22 wood thickness	100 Pcs
20-00-038	Strengthening for Centerline 13/22 x 23/73 for 17/24 wood thickness	100 Pcs

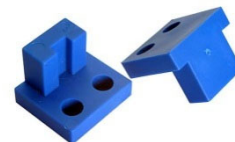
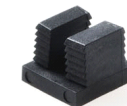

Item no.	Description	Packed by
20-BL-021/MS	Location Set 43/52 in, plastic, reinforced with glass fibre, lightblue	250 Pcs
20-BL-021/S	Screw for Location Set 43/52 in, plastic, reinforced with glass fibre, blue	250 Pcs
20-RT-005/MS	Location Set 1 71/92 in, plastic, reinforced with glass fibre , red	250 Pcs
20-RT-005/M	Nut for Location Set, plastic, reinforced with glass fibre, red	250 Pcs
20-RT-005/S	Screw for Location Set 1 71/92 in, plastic, reinforced with glass fibre, red	250 Pcs
20-BL-005/MS	Location Set 1 71/92 in, plastic, reinforced with glass fibre, lightblue	250 Pcs
20-BL-005/M	Nut for Location Set, plastic, reinforced with glass fibre, lightblue	250 Pcs
20-BL-005/S	Screw for Location Set 1 71/92 in, plastic, reinforced with glass fibre, lightblue	250 Pcs
20-OR-004/MS	Location Set 1 31/32 in, plastic, reinforced with glass fibre, orange	250 Pcs
20-OR-004/M	Nut for Location Set, plastic, reinforced with glass fibre, orange	250 Pcs
20-OR-004/S	Screw for Location Set 1 31/32 in, plastic, reinforced with glass fibre, orange	250 Pcs
20-BL-004/MS	Location Set 1 31/32 in, flat top, plastic, reinforced with glass fibre, lightblue	250 Pcs
20-BL-004/S	Screw for Location Set 1 31/32 in, plastic, reinforced with glass fibre, lightblue	250 Pcs
20-SZ-014/MS	Location Set 1 31/32 in, flat top, plastic, reinforced with glass fibre, black	250 Pcs
20-ML-40.RT	A&MaxLock Centering Bolt Red 1 31/32 in height of striping die	
20-EP-013	Edgeprotec for 22/43 in plywood, black	500 Pcs
20-EP-015	Edgeprotec for 13/22 in plywood, red	500 Pcs
20-EP-018	Edgeprotec for 17/24 in plywood, orange	500 Pcs



Item no.	Description	Packed by
20-SP01	Speedpin For dynamic stripping of solid cardboards to replace the need for setting conventional lower stripping pins (underpins).	500 Pcs
20-MJ1-RT	A&MaxJump A total new design for effective and productive sheet movement.	500 Pcs
20-SZ-033.25	Clamping Jaw plastic, for female stripping board black for 62/63 in reinforcement	50 Pcs
20-SZ-033.35	Clamping Jaw plastic, for female stripping board black for 1 17/45 in reinforcement	50 Pcs
20-SZ-033.50	Clamping Jaw plastic, reinforced with glasfibre for female stripping board black for 1 31/32 in reinforcement	50 Pcs
20-SZ-033/M6.25	Clamping Jaw plastic, glasfibre reinforced, for female stripping board black for 62/63 in reinforcement, with nuts and screws	50 Pcs
20-SZ-033/M6.35	Clamping Jaw plastic, glasfibre reinforced, for female stripping board black for 1 17/45 in reinforcement, with nuts and screws	50 Pcs
20-SZ-033/M6.50	Clamping Jaw plastic, glasfibre reinforced, for female stripping board black for 1 31/32 in reinforcement, with nuts and screws	50 Pcs
20-00-051	Small clamp block 62/63 in	50 Pcs
20-00-051.1	Bothside clamp block 62/63 in	50 Pcs
20-00-006.10	Seperating Knifes for female stripping board designed for 37/94 in die board	100 Pcs
20-00-006/13	Seperating Knifes for female stripping board designed for 43/91in and 22/43 in die board	100 Pcs
20-00-006/13.150.61	Seperating Knifes for female stripping board designed for 43/91 in die board length 5 48/53 x 2 2/5 in special type	100 Pcs

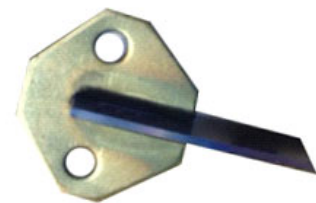
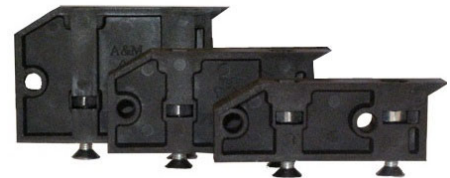

Special lengths upon request

Item no.	Description	Packed by
20-00-018	Aluminium profile U - Non Notched, 3 15/16 x 1 31/32 x 62/63 in, two holes with distance 1 23/40 in	50 Pcs
20-00-018/L	Aluminium profile U - Notched left side 3 15/16 x 1 31/32 x 62/63 in, notched to 37/40 x 36/59 in, two holes with distance 1 23/40 in	25 Pcs
20-00-018/R	Aluminium profile U - Notched right side 3 15/16 x 1 31/32 x 62/63 in, notched to 37/40 x 36/59 in, two holes with distance 1 23/40 in	25 Pcs
20-00-018/RLS	Aluminium profile U - Notched both sides 3 15/16 x 1 31/32 x 62/63 in, notched to 37/40 x 36/59 in, two holes with distance 1 23/40 in	25 Pcs
20-00-004	Tie Rod for blanker Sprintera incl. nut and screw	25 Set
20-00-004.1	Tie Rod for blanker Sprintera 0502000RK	25 Pcs
20-00-015	Mushroom Screw for Quicklock System	100 Pcs
20-00-090.10	Spring loaded underpin SP 4 48/91 in, Ø 37/94 in	50 Pcs
20-00-090.8	Spring loaded underpin SP 4 48/91 in, Ø 23/73 in	50 Pcs
20-00-090.H3	Holder for Spring loaded underpin with 3 threads length 1 2/11 in	100 Pcs
20-00-090.H5	Holder for Spring loaded underpin with 5 threads length 1 71/92 in	100 Pcs
20-00-090.H7	Holder for Spring loaded underpin with 7 threads length 3 3/95 in	100 Pcs
20-00-014	Routing Tool for female stripping die, 30 °, Shaft 37/47 x 23/73 in, total length = 1 17/26 in	1 Pcs



T-Nuts

Item no.	Thread	Height	HeadØ	Packed by
20-00-010	M 4	13/55 in	13/22 in	250 Pcs
20-00-011	M 5	23/73 in	2/3 in	250 Pcs
20-00-012	M 6	17/48 in	3/4 in	250 Pcs
20-00-013	M 8	13/30 in	13/15 in	250 Pcs
10-00-009	M10	22/43 in	62/63 in	250 Pcs
20-00-007	21/79 in	13/30 in	13/15 in	250 Pcs



Item no.	Description	Packed by
21-DBM0-10	Distance pin for Fork	100 Pcs
21-EDL0-14	Driving mandrel Strip Fork maxi	1 Pcs
21-EDM0-12	Driving mandrel Strip Fork medium	1 Pcs
21-MLRR-10	Measuring tool for Register Rod	1 Pcs
21-MLSC-08	Measuring tool for Strip Clip mini	1 Pcs
21-MLSC-10	Measuring tool for Strip Clip medium	1 Pcs
21-MLSC-16	Measuring tool for Strip Clip maxi	1 Pcs
21-RRL0-40	Register Rod 1 23/40 in	100 Pcs
21-RRS0-20	Register Rod 37/47 in	100 Pcs
21-SCS0-10	Strip Clip mini	700 Pcs
21-SCM0-12	Strip Clip medium	1200 Pcs
21-SCL0-18	Strip Clip maxi	600 Pcs
21-SGC0-13	Single Clip	1000 Pcs
21-SFS3-03	Strip Fork mini	250 Pcs
21-SFM1-00	Strip Fork medium	500 Pcs
21-SFM3-00	Strip Fork medium, with 3 pins	500 Pcs
21-SFM3-03	Strip Fork medium, with 3 teeth pins	500 Pcs
21-SFL1-01	Strip Fork maxi, with 1 teeth pins	500 Pc



Parts for blankers

Item no.	Description	Packed by
25-00-006.01	M-Spot-Presser guide for blankers,	50 Pcs
25-00-006.02	M-Spot-Presser guide for blankers, marbapusher-s	25 Pcs
25-00-002.01	M-Presser guide for blankers with elongated hole,	10 Pcs
25-00-003.62	Side guides for blankers, fastening with thread M4 or welding,	50 Pcs
25-00-007	M-Side Guide plastic, long version	50 Pcs
20-00-045	Centering piece, red, for blankers	100 Pcs
20-ESTRI15.01	Estri Pusher 13/22 in for male Striperdie	50 Pcs
25-ESTRI.01	Estri Pusher for blanking	50 Pcs



Stripping forks

Item no.	Height	Width	Packed by
23-50-040/L	1 31/32 in	3/19 in	125 Pcs
23-50-040/R	1 31/32 in	3/19 in	125 Pcs
23-50-060/L	1 31/32 in	13/55 in	125 Pcs
23-50-060/R	1 31/32 in	13/55 in	125 Pcs
23-50-080/L	1 31/32 in	23/73 in	125 Pcs
23-50-080/R	1 31/32 in	23/73 in	125 Pcs
23-50-100/L	1 31/32 in	37/94 in	125 Pcs
23-50-100/R	1 31/32 in	37/94 in	125 Pcs
23-50-120/L	1 31/32 in	43/91 in	125 Pcs
23-50-120/R	1 31/32 in	43/91 in	125 Pcs
23-50-150/L	1 31/32 in	13/22 in	125 Pcs
23-50-150/R	1 31/32 in	13/22 in	125 Pcs
23-50-200/L	1 31/32 in	37/47 in	125 Pcs
23-50-200/R	1 31/32 in	37/47 in	125 Pcs



Special Stripper Pins Type /F

with shoulder, flat top, base - diameter = 3/19 in

Item no.	Ø	Wood thickness	Length	Packed by
21-15-020/F	3/38 in	13/22 in	1 31/32 in	250 Pcs
21-15-030/F	2/17 in	13/22 in	1 31/32 in	250 Pcs
21-15-040/F	3/19 in	13/22 in	1 31/32 in	250 Pcs
21-15-050/F	12/61 in	13/22 in	1 31/32 in	250 Pcs
21-15-060/F	13/55 in	13/22 in	1 31/32 in	250 Pcs
21-15-070/F	8/29 in	13/22 in	1 31/32 in	250 Pcs
21-15-080/F	23/73 in	13/22 in	1 31/32 in	250 Pcs
21-15-100/F	37/94 in	13/22 in	1 31/32 in	250 Pcs
21-15-120/F	43/91 in	13/22 in	1 31/32 in	250 Pcs



Further dimensions upon request

Special Stripper Pins Typ /S

with shoulder and pinpoint, base - diameter = 3/19 in

Item no.	Ø	Wood thickness	Length	Packed by
21-15-020/S	3/38 in	13/22 in	1 31/32 in	250 Pcs
21-15-030/S	2/17 in	13/22 in	1 31/32 in	250 Pcs
21-15-040/S	3/19 in	13/22 in	1 31/32 in	250 Pcs
21-15-050/S	12/61 in	13/22 in	1 31/32 in	250 Pcs
21-15-060/S	13/55 in	13/22 in	1 31/32 in	250 Pcs
21-15-070/S	8/29 in	13/22 in	1 31/32 in	250 Pcs
21-15-080/S	23/73 in	13/22 in	1 31/32 in	250 Pcs
21-15-100/S	37/94 in	13/22 in	1 31/32 in	250 Pcs
21-15-120/S	43/91 in	13/22 in	1 31/32 in	250 Pcs

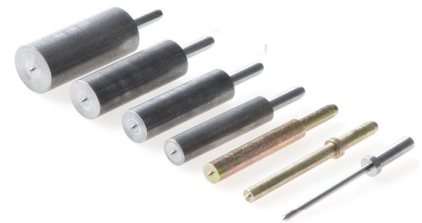

Further dimensions upon request

Crown Pins

with shoulder

Item no.	Ø	FootØ	Length	Packed by
21-16-020.K	3/38 in	3/19 in	1 31/32 in	200 Pcs
21-16-030.K	2/17 in	3/19 in	1 31/32 in	200 Pcs
21-16-040.K	3/19 in	3/19 in	1 31/32 in	200 Pcs
21-16-050.K	12/61 in	3/19 in	1 31/32 in	200 Pcs
21-16-060.K	13/55 in	3/19 in	1 31/32 in	200 Pcs
21-16-080.K	23/73 in	3/19 in	1 31/32 in	200 Pcs
21-16-100.K	37/94 in	3/19 in	1 31/32 in	200 Pcs



Rotary Supplies



Perfect in die-supplies

Supplies for Martin Machines

Supplies for Martin – die cutting machines with Quick-release-system

Item no.	Description	Packed by
40-00-001.1	Quick release clamp „Premium“ Ø = 10 37/58 in Unbreakable quality made of aluminium with double sided milled chamfered edges and pressed threads. For Martin 924	50 Pcs
40-00-002.1	Quick release clamp „Premium“ Ø = 14 5/12 in Unbreakable quality made of aluminium with double sided milled chamfered edges and pressed threads For Martin 1228	50 Pcs
40-00-003.1	Quick release clamp „Premium“ Ø = 19 2/11 in Unbreakable quality made of aluminium with double sided milled chamfered edges and pressed threads For Martin 1628	50 Pcs
40-00-004.1	Quick release clamp „Premium“ Ø = 6 31/32 in Unbreakable quality made of aluminium with double sided milled chamfered edges and pressed threads For Martin 616 or 718	50 Pcs
40-00-005	Cup washer 8/29 x 13/22 in, for screws M6, nickel-plated	500 Pcs
DIN7991-M6x18 DIN7991-M6x22	Quick release clamp retaining screws galv. M6 x 17/24 in or 13/15 in lengths	500 Pcs



Fastening parts for rotary - dies

Item no.	Description	Packed by
51-00-060	Power Lock 43/91 in to reinforce the fit of the cutting rule	50 Pcs
51-00-025	Drive in Washer, diam. Outside = 1 1/16 in, diam. Inside = 43/91 in	1.000 Pcs
51-00-026	Drive in Washer Slotted, diam. Outside = 1 1/16 in, diam. Inside = 37/94 : 22/43 in	1.000 Pcs
51-00-011	Elongated Plan Washer thickness 1/17 in, Outside 3 x 1 2/11, Inside, 2 21/58 x 43/91 in	100 Pcs
Camping Frame for mounting rotary shells with a very short set up time 50-00-016.060/080 for slot length 2 21/58 in 50-00-016.090/110 for slot length 3 25/46 in 50-00-016.100/120 for slot length 3 15/16 in		2 Pcs
51-00-040	Serapid mounting plate 2/17 in, 2 37/58 x 1 2/11 in and cut out 3/4 x 55/72 in	500 Pcs
51-10-001	Stopper or Creasing Rules hold creasing rules in the wood, stops breaking outside special alloy 13/15 x 13/55 in, hole diam. = 2/17 in	200 Pcs
51-00-050	Fixing Part for Rotary steel 43/78 x 1 23/40 in	2 Pcs
50-00-040	Handles for dies. Eases Transport.	100 Pcs
50-00-033	Special Nippers for short setups of two rotation dies	200 Pcs

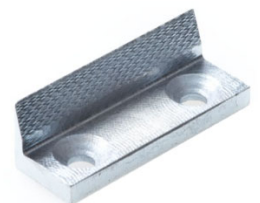

SPEEDMOUNT_{plus}

The smart mounting system for rotary tools.

Saves time • Reduces costs • Increases accuracy and service life of your tools.

With **SPEEDMOUNT_{plus}** you reduce the equipment of the mounting holes time required for laser-cut rotary dies by up to 75%.

So far, the rotation shells were drilled, countersunk and fitted with metal discs to reinforce the mounting holes. Normally when working on a two shelled tool in 6,6 ft lengths it will take about 35 minutes. This is now a thing of the past.

With **SPEEDMOUNT_{plus}** you get the flexibility to provide various wood thicknesses an absolutely robust fastening system which completely accommodates the heads of the fastening screws and thus excludes the footprints on the Cutting material.

Replacing holes operations without reworking the wood?

With **SPEEDMOUNT_{plus}** irreparable torn mounting holes and extensive work are a thing of the past. – Simply replace the inserts or retrofitted to old tools with metal discs with repairs by drilling the defective mounting holes and replace them with our **SPEEDMOUNT Plus**. There are almost no limits on any machine diameter.

SPEEDMOUNT_{plus} you get ready to install with 43/91 in round hole - or elongated hole 43/91 x 13/22 in for faster set-up in multi-piece tools – the 1st shell is equipped with round hole inserts, all other shells with elongated hole inserts. For slots in part tools, a version is available that allows shifting of more than 1 31/32 inch in radial or axial direction.



Item no.	Description	Packed by
51-RT-027	SPEEDMOUNT _{plus} , red, with hole 43/91 in, for 22/43 in wood-thickness	250 Pcs
51-RT-028	SPEEDMOUNT _{plus} , red, with elongated hole 31/75 x 13/22 in, for 22/43 in wood thickness	250 Pcs
51-BL-027	SPEEDMOUNT _{plus} , blue, with hole 43/91 in, for 22/43 in wood-thickness	250 Pcs
51-BL-028	SPEEDMOUNT _{plus} , blue, with elongated hole 31/75 x 13/22 in, for 22/43 in wood thickness	250 Pcs
51-10-028	Speedmounts Aluminum with hole 3/8 x 13/22 in	1000 Pcs
51-10-028.1	Speedmounts Aluminum with hole 13/30 x 17/24 in	1000 Pcs



DuroCorr The Perfect Fit...

A&M Stanzformzubehör Olaf Abendroth GmbH / www.aundm.eu / info@aundm.eu / Tel.: +49 7151 910 500 0 / Fax: +49 7151 910 500 9

A&M DuroCorr Anvil Covers



Application:

Specially designed for screw-less mounting on the cylinder with ease for both standard and modified channels.

The most important unique features at a glance:

- Available for the most machines currently on the market
- User-friendly installation characteristics due to the great bidirectional design
- Low wear due to scientifically optimized material mixtures
- Minimizing machine downtime and therefor reducing costs
- Majorly Increasing productivity
- Outstanding customer support and technical know-how
- Just-In-Time Delivery

A&M DuroCorr - a guarantee for maximum reliability and added value!

Interested? Questions?
Contact us!

A&M Die Supplies

Tel.: +49 (0) 7151 910500 0
Homepage: www.aundm.eu
Email: info@aundm.eu



TrimSaver® 2

System

REVOLUTION IN ROTARY DIECUTTING

FEATURES & BENEFITS

Less operational downtime

Reduced trim accumulation and improved durability keeps your machine moving

Reduced die-cutting pressure

Lower pressure and lead edge impact reduces anvil cover wear as well as stress on both die and machine

Increased production speed

Improved trim waste control and powerful ejection enables faster converting

Reduced sheet sizes

Requires less trim and smaller sheets

Positive environmental impact

Lower rates of paper consumption, less water and energy usage, and reduced waste

The patented TrimSaver® system significantly impacts your operation with increased converting performance through better trim waste control.

TrimSaver® applies pressure to the whole surface of the trim area and blocks any gap in which small waste can get stuck. The system's design provides a powerful ejection to strip away waste on even the smallest trim sizes. This advanced 3-step process of pressuring, blocking and ejecting provides advanced control and results in a perfect cut every time.

The system's superior performance can save up to 66% on trim waste by reducing the total sheet size by an average of 2%. Because of its superior control, the TrimSaver® system can work with reduced trim of as little as 3/8" (9,5 mm) lead and trail edge total trim and 1/4" (6,35 mm) total side trim.

TrimSaver® 2 improves the system's performance on the lead edge, using a wider and more dynamic profile combined to a precisely calibrated motion.



Trim Saver®

Item no.	Description	Packed by
11-TSL-3/8	Trim Saver® Lead for ejection on paper machinery and tooling, black	1000 Pcs
11-TSL-N4	Lead & Trail Knife 4pt, 1 x 1 in	500 Pcs
11-TSS-3/8-1	Trim Saver® side trail for ejection on paper machinery and tooling, red	1000 Pcs
11-TSS-N4	Side Trim Knife 4pt, 1 2/85 x 15/16 in	500 Pcs
11-TSL-THREE	Trim Saver® 3 Trail Edge	1000 Pcs



Tools & Accessories For Diemaking



Perfect in die-supplies

PerfaTypes A&M Max

Font height 37/47 inch, in mirror writing, nailable or used with perfa holders.

Item no.	Description	Packed by
50-00-003/A - Z	Perfa – Types marking letters and numbers, mirror writing, nailable	25 Pcs
50-00-003/0 - 9	Perfa – Types marking numbers, mirror writing, nailable	25 Pcs
50-00-003/ 50-00-003/- 50-00-003//	Perfa – Type Standard dot, minus and slash sign, mirror writing, nailable	25 Pcs
50-00-003/# 50-00-003/@	Perfa – Types # and @, mirror writing, nailable	25 Pcs
50-00-003/GF	Perfa – Types Glue flap, mirror writing, nailable	25 Pcs
50-00-004.2-18	Perfa - Type Holder with nose, length 3,3 ft, base height 1/14 in, red	25 Pcs
50-00-004.2-25	Perfa - Type Holder with nose, length 3,3 ft, base height 6/61 in, dark blue	25 Pcs
50-00-004.2-30	Perfa - Type Holder with nose, length 3,3 ft, base height 2/17 in, green	25 Pcs
50-00-004.2-35	Perfa - Type Holder with nose, length 3,3 ft, base height 4/29 in, black	25 Pcs

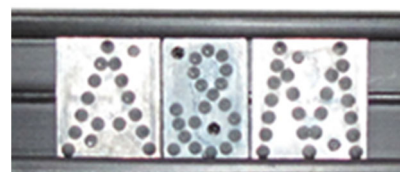
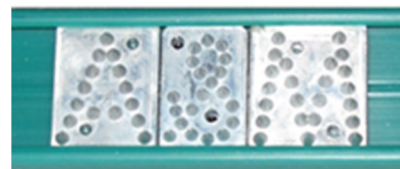
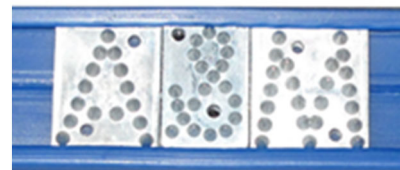

PerfaTypes A&M Medi

Font height 13/22 inch, in mirror writing, nailable or used with perfa holders.

Item no.	Description	Packed by	
50-00-005/A - Z	PerfaTypes A&M Medi Letters A - Z mirror writing, nailable,	25 Pcs	
50-00-005/0 - 9	PerfaTypes A&M Medi Letters 0 - 9 mirror writing, nailable	25 Pcs	
50-00-005/. 50-00-005/- 50-00-005//	PerfaTypes A&M Medi dot, minus and slash, mirror writing, nailable	25 Pcs	
50-00-005/# 50-00-005/@	PerfaTypes A&M Medi @ and # mirror writing, nailable	25 Pcs	
50-00-004.13-18	Perfa - Type Holder with nose for A&M Medi length 3,3 ft, base height 1/14 in, red	25 Pcs	
50-00-004.13-25	Perfa - Type Holder with nose for A&M Medi length 3,3 ft, base height 6/61 in, blue	25 Pcs	
50-00-004.13-30	Perfa - Type Holder with nose for A&M Medi length 3,3 ft, base height 2/17 in, green	25 Pcs	
50-00-004.13-35	Perfa - Type Holder with nose for A&M Medi length 3,3 ft, base height 4/29 in, black	25 Pcs	

PerfaTypes A&M Mini

Font height 37/94 inch, in mirror writing, nailable or used with perfa holders.

Item no.	Description	Packed by
50-00-002/A - Z	PerfaTypes A&M Mini Letters A - Z mirror writing, nailable	25 Pcs
50-00-002/0 - 9	PerfaTypes A&M Mini Numbers 0 - 9 mirror writing, nailable	25 Pcs
50-00-002/- 50-00-002//	PerfaTypes A&M Mini minus and slash mirror writing, nailable	25 Pcs
50-00-004.6	End piece to fix the Mini - Type on the Mini - Type Holder	25 Pcs
50-00-004.3-08	Perfa - Type Holder with nose for A&M Mini, length 3,3 ft, base height 1/32 in, red	25 Pcs
50-00-004.3-25	Perfa - Type Holder with nose for A&M length 3,3 ft, base height 6/61 in, dark blue	25 Pcs
50-00-004.3-30	Perfa - Type Holder with nose for A&M Mini length 3,3 ft, base height 2/17 in, black	25 Pcs
50-00-004.3-45	Perfa - Type Holder with nose for A&M Mini, length 3,3 ft, base height 14/79 in, red	25 Pcs



Perforating parts

Item no.	Description	Packed by
50-00-004.4	Resy sign nailable at the cutting die size abt. 2 3/5 x 2 41/93 in	20 Pcs
50-00-004.3	Resy sign Medi nailable at the cutting die, size abt. 1 23/40 x 1 23/40 in	25 Pcs
50-00-004.5	Resy sign Mini nailable at the cutting die, size abt. 62/63 x 62/63 in	25 Pcs
50-00-004.8	Recycling sign international nailable at the cutting die, size abt. 2 52/93 x 2 52/93 in	20 Pcs
50-00-004.9	Recycling sign mini international nailable at the cutting die size abt. 62/63 x 62/63 in	25 Pcs
50-00-004.11	Recycling Symbol "Green dot" size appr. 2 1/21 x 2 1/21 in	20 Pcs
50-00-004.12	Recycling Symbol "Green dot", mini size, appr. 62/63 x 62/63 in	25 Pcs
50-00-004.10	FSC sign nailable at the cutting die size abt. 2 3/5 x 2 41/93 in	20 Pcs
50-00-004.14	Recycling symbol PAP20 nailable at the cutting die, size abt. 2 3/5 x 2 41/93 in	20 Pcs
50-00-004.17	Recycling symbol PAP20 Mini, nailable at the cutting die, size abt. 1 17/45 x 1 2/11 in	25 Pcs
50-00-020	Steel Nail for Perforating Types, 3/38 x 17/27 in	1.000 Pcs
50-00-019	Embossing Pin 13/14 x 3/38 in	1.000 Pcs



Tools for Diemaking

Item no.	Description	Packed by
50-00-025	Polyurethane Mallet, No. 4, Head, 2 1/21 x 5 2/17 in, Hickory, shaft 1 ft	5 Pcs
50-00-026	Polyurethane Mallet No. 7, Head 2 20/21 x 5 2/17 in, Hickory shaft 1 ft	5 Pcs
50-SO-025	Polyurethane Mallet "Premium", Head 2 1/21 x 4 48/91 in, Hickory shaft 1 ft	5 Pcs
50-SO-026	Polyurethane Mallet "Premium", Head 2 20/21 x 4 48/91 in, Hickory shaft 1 ft	5 Pcs
50-00-008	Aluminiumhammer, cask design, 0,55 lbs	5 Pcs
50-00-022	Copperhammer sledge handforged, 0,66 lbs	5 Pcs
50-00-011	Simplex - Hammer with exchangeable rawskinparts, 1,32 lbs	5 Pcs
50-00-012	Simplex - Hammer with exchangeable aluminiumparts 1,48 lbs	5 Pcs
50-00-013	Rawhide Part for order no. 50-00-011	10 Pcs
50-00-014	Aluminium Part for order no. 50-00-012	10 Pcs
50-00-009	Rawhide Mallet, cask design, 0,57 lbs, Ø 1 71/92 x 3 25/46 in	5 Pcs
50-00-010	Rawhide Mallet cask design 0,84 lbs, Ø 2 1/21 x 4 2/15 in	5 Pcs
50-00-018	Rawhide Mallet cask design, 1,21 lbs, Ø 2 41/93 x 4 15/17 in	5 Pcs
50-00-021	Rawhide Mallet cask design, 1,54 lbs, Ø 2 65/86 x 5 2/17 in	5 Pcs
50-00-027	Aluminiumhammer cask design 62/63 x 7 7/8 in	5 Pcs



Accessories

Item no.	Description	Packed by
50-00-035	Corrugated Nails 17/48 x 12/61 x 62/63 in	1.000 Pcs
50-00-036	43/91 x 12/61 x 62/63 in	1.000 Pcs
50-00-037	13/22 x 12/61 x 62/63 in	1.000 Pcs
50-00-038	17/24 x 12/61 x 62/63 in	1.000 Pcs



50-00-028	Rule puller A&Maxtractor for 2pt to 3pt rules	1 Pcs
-----------	---	-------



50-00-050	Rule puller A&M Rule Ruler "Heavy Duty" for 2pt up to 3pt rules, up to 1 31/32 in high	1 Pcs
-----------	--	-------



50-00-023	Rule straightening tool, to bend the rule in position. Recommended for 2 pt. and 3 pt. rules	1 Pcs
-----------	--	-------



Ejection Material

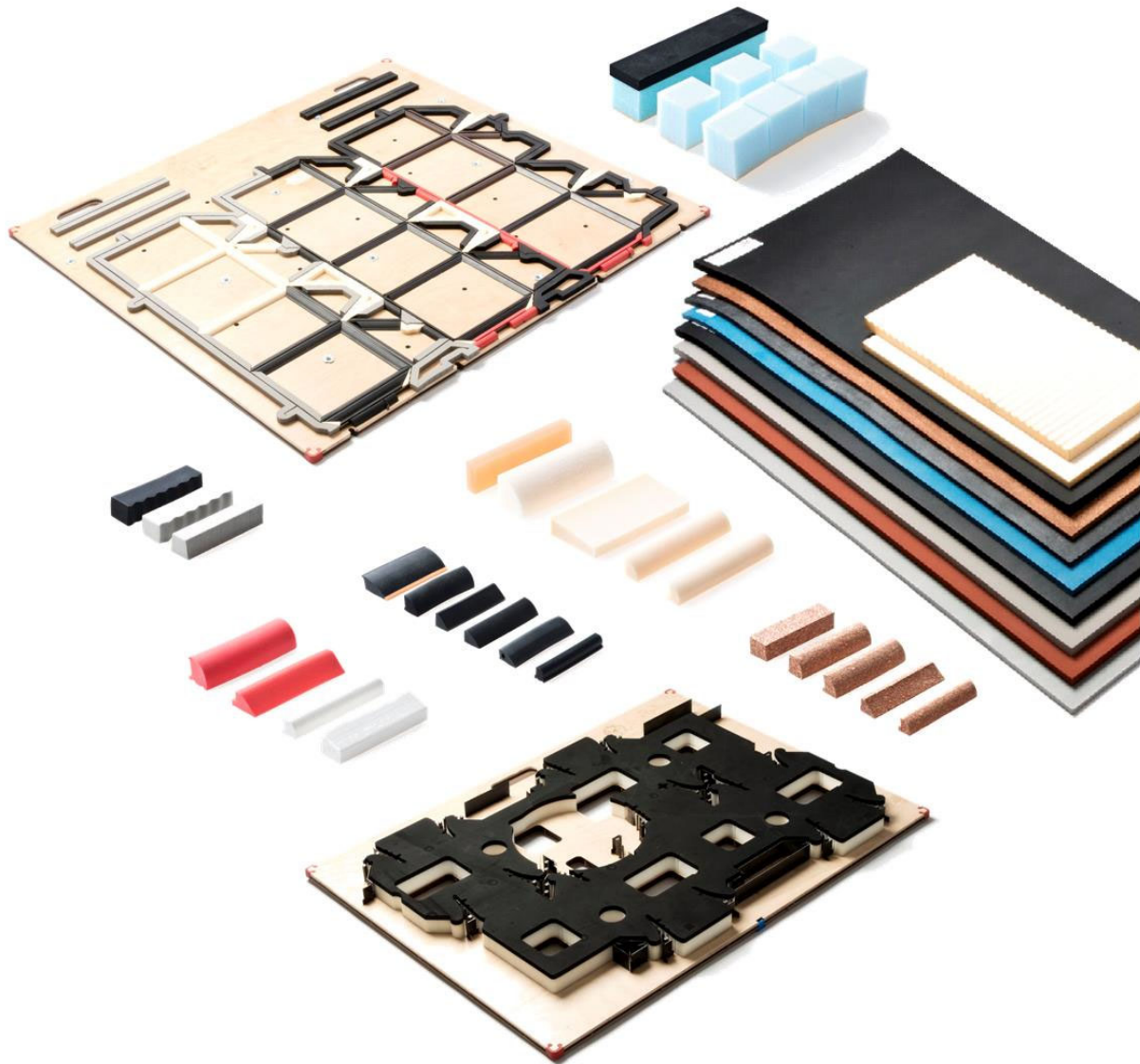

Perfect in die-supplies

Open Cell 15° Shore A

Item no.	Thickness	Length	Width	Skin	Colour	Packed by
87-15-070/SZE	8/29 in	3,3 ft	3,3 ft	1	Black	1 Sheet / s



Further dimensions possible upon request!!

Open cell 25° Shore A

Item no.	Thickness	Length	Width	Skin	Colour	Packed by
87-25-070/GR	8/29 in	3,3 ft	3,3 ft	2	Grey	1 Sheet / s
87-25-070/GRE	8/29 in	3,3 ft	3,3 ft	1	Grey	1 Sheet / s
87-25-080/GR	23/73 in	3,3 ft	3,3 ft	2	Grey	1 Sheet / s
87-25-100/GR	37/94 in	3,3 ft	3,3 ft	2	Grey	1 Sheet / s
87-25-100/GRE	37/94 in	3,3 ft	3,3 ft	1	Grey	1 Sheet / s



Further dimensions possible upon request!!

Two sided Self – Adhesive sheets :

87-25-090/GROH.2SKJ	17/48 in	3,3 ft	3,3 ft	0	Grey	1 Sheet / s
---------------------	----------	--------	--------	---	------	-------------

Open cell 35° Shore A

Item no.	Thickness	Length	Width	Skin	Colour	Packed by
87-35-070/GR	8/29 in	3,3 ft	3,3 ft	2	Grey	1 Sheet / s
87-35-070/GRE	8/29 in	3,3 ft	3,3 ft	1	Grey	1 Sheet / s
87-35-070/BLE	8/29 in	3,3 ft	3,3 ft	1	blue	1 Sheet / s
87-35-070/RTE	8/29 in	3,3 ft	3,3 ft	1	Red	1 Sheet / s
87-35-080/GR	23/73 in	3,3 ft	3,3 ft	2	Grey	1 Sheet / s
87-35-100/GRE	37/94 in	3,3 ft	3,3 ft	1	Grey	1 Sheet / s
87-35-110/GRE	13/30 in	3,3 ft	3,3 ft	1	Grey	1 Sheet / s

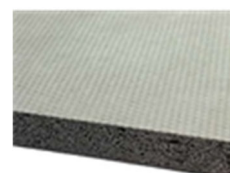

Further dimensions possible upon request!!

Rubbercork N65

65° Shore A

Item no.	Thickness	Length	Width	Packed by
84-65-020	3/38 in	2,1 ft	3,3 ft	5 Sheets
84-65-030	2/17 in	2,1 ft	3,3 ft	5 Sheets
84-65-040	3/19 in	2,1 ft	3,3 ft	5 Sheets
84-65-050	12/61 in	2,1 ft	3,3 ft	5 Sheets
84-65-060	13/55 in	2,1 ft	3,3 ft	5 Sheets
84-65-070	8/29 in	2,1 ft	3,3 ft	5 Sheets
84-65-080	23/73 in	2,1 ft	3,3 ft	5 Sheets
84-65-090	17/48 in	2,1 ft	3,3 ft	5 Sheets
84-65-095	3/8 in	2,1 ft	3,3 ft	5 Sheets
84-65-100	37/94 in	2,1 ft	3,3 ft	5 Sheets
84-65-110	13/30 in	2,1 ft	3,3 ft	5 Sheets
84-65-120	43/91 in	2,1 ft	3,3 ft	5 Sheets



Further dimensions possible upon request!!

Rubbering of rotaty dies

You need to fix ejection rubber on the die board (shell) to avoid the board sticking between the rules on the die board. The rubber pushes the corrugated out of the die after the cutting process.

Depending on the requirement there are three different groups of rubbers used on rotary dies:

- Blank ejection
- Waste stripping
- Creasing support

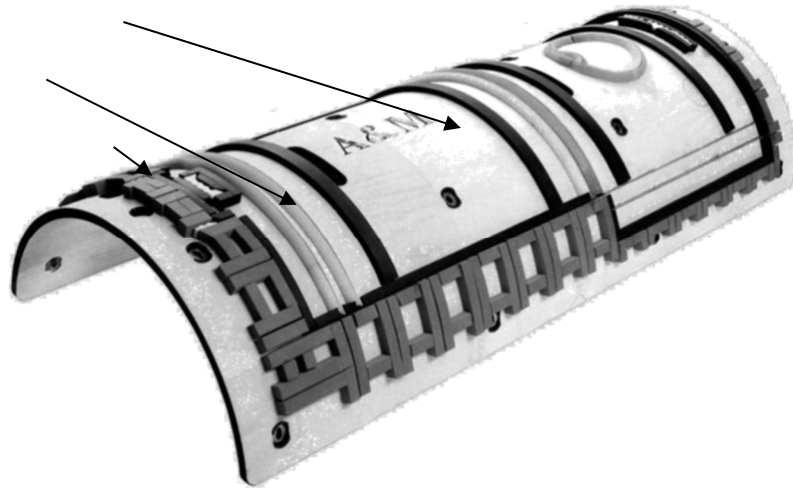

Board Ejection

Generally the ejection rubber should not be compressed more than 50% of its height. We recommend a value of maximum 40%.

Furthermore the quality of the cut is influenced by the right choice of wood thickness and the specifications of the ejection material.

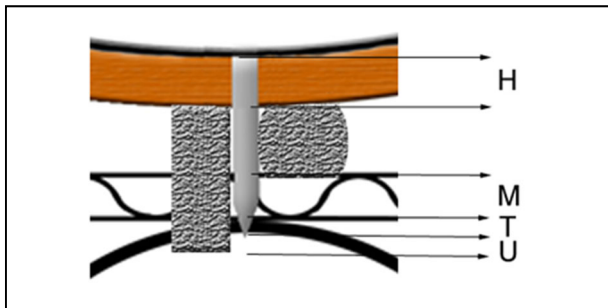

Pict.: 40 % compression of the ejection rubber.

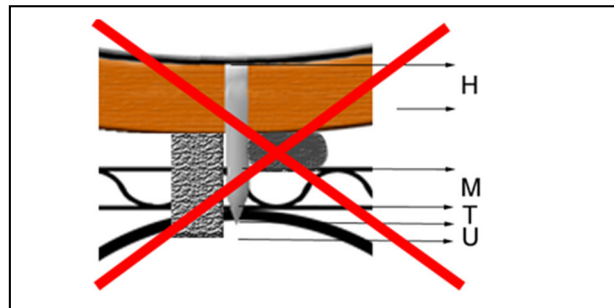

Pict.: 40 % compression of the ejection rubber.

$$KG = ((Re+U) - (U+T+M)) / (Re+U) \text{ respectively } KG = ((R-H)+U) - (U+T+M) / ((R-H)+U)$$

The compression at the moment of board penetration shouldn't be more than 40 – 50 %

Derivation

H (plywood/Die board)	=	13,0 mm	
M (material)	=	3,0 mm	
T (immersion depth)	=	1,4 mm (Soll 1 – 2 mm)	
U (overhang)	=	1,6 mm (Soll 1 – 2 mm)	
R (rule height)	=	25,4 mm (Standard)	
Re (rule height eff.)	=	12,4 mm	
X (rubber height complete)	=	14,0 mm	
Y (compression)	=	6,0 mm	
Z (rubber height compr.)	=	8,0 mm	
KG (compression value)	=	42,86 %	

1) Re	=	R – H	25,4 – 13	=	12,4
2) X	=	Re + U	12,4 + 1,6	=	14
3) Y	=	U + T + M	1,4 + 1,6 + 3	=	6

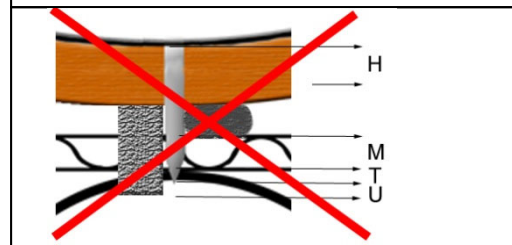
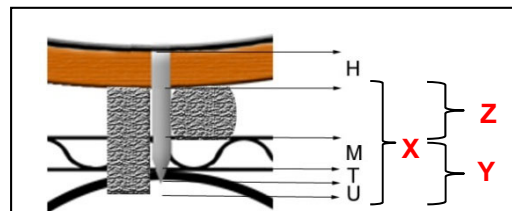

Board Ejection

Material / **A&M**neo

Most effective rubber for this application is A&Mneo (Neopren). It is designed and developed for a long life and it reaches the efforded rebound although the consistency is relatively.

The board is ejected fastly without ugly and unwanted preassure marks

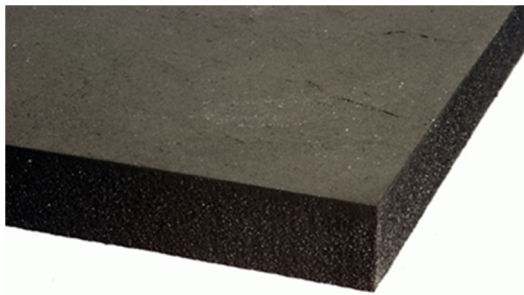

Basis: Synthetic / CR
Weight: 240 Kg/ m³
Durability: > 5 years
Rebound resilience: very high
Fatigue: low
Cell structure: small
Elongation: high, at 60 %
Compression deflecion: 60 – 130 kPa/cm² (at 50%)

Gasgummi **A&M**neo

One side skin, High Performance ejection material for corrugated board

Item no.	Thickness	Length	Width	Packed by
83-17-070/H	8/29 in	3,3 ft	1,6 ft	5 Sheets
83-17-080/H	23/73 in	3,3 ft	1,6 ft	5 Sheets
83-17-100/H	37/94 in	3,3 ft	1,6 ft	5 Sheets
83-17-110/H	13/30 in	3,3 ft	1,6 ft	5 Sheets
83-17-120/H	43/91 in	3,3 ft	1,6 ft	5 Sheets
83-17-140/H	43/78 in	3,3 ft	1,6 ft	5 Sheets
83-17-160/H	17/27 in	3,3 ft	1,6 ft	5 Sheets
83-17-180/H	17/24 in	3,3 ft	1,6 ft	5 Sheets

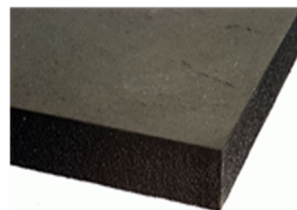

Further dimensions possible upon request!!

Gas Rubber NR52N

EPDM, without Skin, black

Item no.	Thickness	Length	Width	Packed by
83-22-070	8/29 in	3,3 ft	3,3 ft	5 Sheets
83-22-080	23/73 in	3,3 ft	3,3 ft	5 Sheets
83-22-100	37/94 in	3,3 ft	3,3 ft	5 Sheets
83-22-110	13/30 in	3,3 ft	3,3 ft	5 Sheets



Further dimensions possible upon request!!

Gas Rubber NR52N

EPDM, one-sided Skin, Black

Item no.	Thickness	Length	Width	Packed by
83-22-070/H	8/29 in	3,3 ft	3,3 ft	5 Sheets
83-22-110/H	13/30 in	3,3 ft	3,3 ft	5 Sheets
83-22-140/H	43/78 in	3,3 ft	3,3 ft	5 Sheets
83-22-160/H	17/27 in	3,3 ft	3,3 ft	5 Sheets
83-22-200/H	37/47 in	3,3 ft	3,3 ft	5 Sheets



Further dimensions possible upon request!!

Waste Stripping

Parameter

Except the overhang (U) the parameters don't differ from the rubbering coating of the blanks (see page 41) The overhang should be appr. **5 – 6 mm**.

Material / G900

There is no reason to avoid material deformation at waste ejection. Main objective is to obtain the highest possible pressure level on the material.

The rubber has to gain more force and pressure. For this application we recommend to use G900. This material is based on EPDM with a very small closed-cell structure.

G900 was developed specially for the die making industry, as a waste ejector. In opposition to most materials for this application on the market.

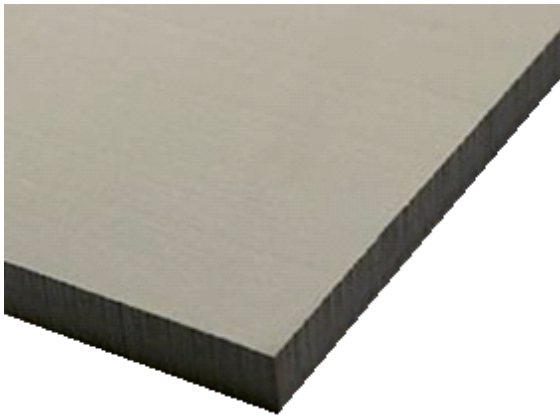

Basis: Synthetic / EPDM

Weight: 300 Kg/ m³

Durability: > 5 years

Rebound resilience: very high

Fatigue: very low

Cell structure: very small

Elongation: high, at 60 %

Compression deflection: 60 – 150 kPa/cm² (at 50%)

A&M G900

High Performance ejection material for rotative diecutting of corrugated board

Item no.	Thickness	Length	Width	Packed by
83-18-070	8/29 in	3,3 ft	3,3 ft	1 Sheet
83-18-080	23/73 in	3,3 ft	3,3 ft	1 Sheet
83-18-100	37/94 in	3,3 ft	3,3 ft	1 Sheet
83-18-110	13/30 in	3,3 ft	3,3 ft	1 Sheet
83-18-120	43/91 in	3,3 ft	3,3 ft	1 Sheet
83-18-140	43/78 in	3,3 ft	3,3 ft	1 Sheet
83-18-150	13/22 in	3,3 ft	3,3 ft	1 Sheet
83-18-160	17/27 in	3,3 ft	3,3 ft	1 Sheet
83-18-180	17/24 in	3,3 ft	3,3 ft	1 Sheet
83-18-190	3/4 in	3,3 ft	3,3 ft	1 Sheet
83-18-200	37/47 in	3,3 ft	3,3 ft	1 Sheet

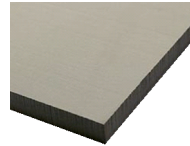

A&M R900

In the waste ejecting sector plays the deformation a subordinate role. To be able to achieve the optimal results, a high pressure should be applied.

The gumming must be able to withstand the high build up of pressure. Therefore we recommend our R900. A very fine-textured material based EPDM - closed cell structure.

Unlike the most common materials on the market, the R900 was specifically designed and developed to be used in the die ejection sector.

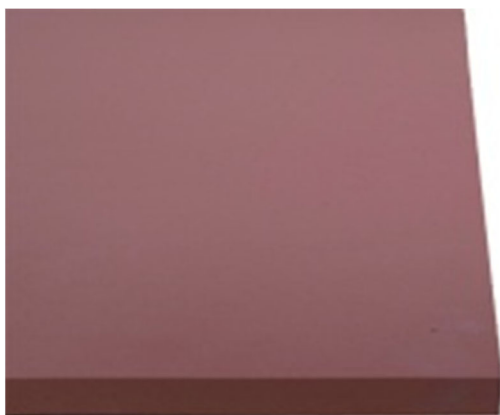

- Basis:** Synthetic EPDM
- Weight:** 300 Kg/ m³
- Durability:** > 5 Jahre
- Rebound resilience:** Very high
- Fatigue:** Very low
- Cell structure:** Very small
- Elongation:** high, at 60 %
- Compression deflection:** 60 – 150 kPa/cm²
(by 50%)
- Colour:** Red

A&M R900 (Red)

High performance ejector material for rotary die cutting- corrugated board

Item no.	Thickness	Length	Width	Packed by
83-18-070.R	8/29 in	3,3 ft	3,3 ft	1 Sheet
83-18-100.R	37/94 in	3,3 ft	3,3 ft	1 Sheet
83-18-110.R	13/30 in	3,3 ft	3,3 ft	1 Sheet
83-18-120.R	43/91 in	3,3 ft	3,3 ft	1 Sheet
83-18-140.R	43/78 in	3,3 ft	3,3 ft	1 Sheet
83-18-150.R	17/27 in	3,3 ft	3,3 ft	1 Sheet
83-18-160.R	17/27 in	3,3 ft	3,3 ft	1 Sheet
83-18-200.R	37/47 in	3,3 ft	3,3 ft	1 Sheet

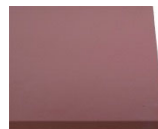

A&M Black Diamond

High performance ejector material for rotary die cutting- corrugated board

Item no.	Thickness	Length	Width	Packed by
83-SP-110	13/30 in	4,3 ft	3,3 ft	1 Sheet



Rubber coating for slots / Cellpolyurethane (example. RG50)

Slotting affords very special requirements on the ejection material.

Because of the very **small space between the cutting rules** in these areas there's accordingly less space for rubber and the forces keeping the waste are much higher than in other areas.

So the rubber must have **maximum rebound resilience** and **minimum elongation**. Vulcan fits perfectly to these requirements and is additionally extreme durable.



Basis: Synthetic / D15

Weight: 500 Kg/ m³

Durability: > 20 years

Rebound resilience: very high

Fatigue: low

structure: mixed

Elongation: very low at 50 %

Compression deflection: 80 – 140 kPa/cm² (at 50%)

Cellpolyurethane Sheet RG 35

Basic material D15, 350 kg/m³

Item no.	Thickness	Width	Length	Packed by
86-35-040/D15	3/19 in	0,8 ft	1,6 ft	26 Sheets
86-35-070/D15	8/29 in	0,8 ft	1,6 ft	15 Sheets
86-35-080/D15	23/73 in	0,8 ft	1,6 ft	13 Sheets
86-35-090/D15	17/48 in	0,8 ft	1,6 ft	11 Sheets
86-35-100/D15	37/94 in	0,8 ft	1,6 ft	10 Sheets
86-35-110/D15	13/30 in	0,8 ft	1,6 ft	10 Sheets
86-35-120/D15	43/91 in	0,8 ft	1,6 ft	9 Sheets
86-35-140/D15	43/78 in	0,8 ft	1,6 ft	7 Sheets
86-35-150/D15	13/22 in	0,8 ft	1,6 ft	7 Sheets
86-35-160/D15	17/27 in	0,8 ft	1,6 ft	7 Sheets
86-35-170/D15	2/3 in	0,8 ft	1,6 ft	6 Sheets
86-35-180/D15	17/24 in	0,8 ft	1,6 ft	6 Sheets
86-35-190/D15	3/4 in	0,8 ft	1,6 ft	6 Sheets
86-35-200/D15	37/47 in	0,8 ft	1,6 ft	5 Sheets



Cellpolyurethane Sheet RG 40

Basic material D15, 400 kg/m³

Item no.	Thickness	Width	Length	Packed by
86-40-030/D15	4/29 in	0,8 ft	1,6 ft	35 Sheets
86-40-040/D15	3/19 in	0,8 ft	1,6 ft	26 Sheets
86-40-060/D15	13/55 in	0,8 ft	1,6 ft	17 Sheets
86-40-070/D15	8/29 in	0,8 ft	1,6 ft	15 Sheets
86-40-100/D15	37/94 in	0,8 ft	1,6 ft	10 Sheets
86-40-110/D15	13/30 in	0,8 ft	1,6 ft	10 Sheets
86-40-120/D15	43/91 in	0,8 ft	1,6 ft	9 Sheets
86-40-140/D15	43/78 in	0,8 ft	1,6 ft	7 Sheets
86-40-160/D15	17/27 in	0,8 ft	1,6 ft	7 Sheets
86-40-170/D15	2/3 in	0,8 ft	1,6 ft	6 Sheets

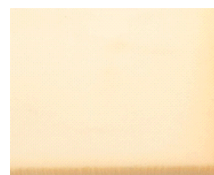

Cellpolyurethane Sheet RG 50

Basic material D15, 500 kg/m³

Item no.	Thickness	Width	Length	Packed by
86-50-020/D15	3/38 in	0,8 ft	1,6 ft	50 Sheets
86-50-030/D15	2/17 in	0,8 ft	1,6 ft	35 Sheets
86-50-040/D15	3/19 in	0,8 ft	1,6 ft	26 Sheets
86-50-050/D15	12/61 in	0,8 ft	1,6 ft	21 Sheets
86-50-060/D15	13/55 in	0,8 ft	1,6 ft	17 Sheets
86-50-070/D15	8/29 in	0,8 ft	1,6 ft	15 Sheets
86-50-080/D15	23/73 in	0,8 ft	1,6 ft	13 Sheets
86-50-090/D15	17/48 in	0,8 ft	1,6 ft	11 Sheets
86-50-095/D15	3/8 in	0,8 ft	1,6 ft	11 Sheets
86-50-100/D15	37/94 in	0,8 ft	1,6 ft	10 Sheets
86-50-110/D15	13/30 in	0,8 ft	1,6 ft	10 Sheets
86-50-120/D15	43/91 in	0,8 ft	1,6 ft	9 Sheets
86-50-130/D15	22/43 in	0,8 ft	1,6 ft	8 Sheets
86-50-140/D15	43/78 in	0,8 ft	1,6 ft	7 Sheets
86-50-150/D15	13/22 in	0,8 ft	1,6 ft	7 Sheets
86-50-160/D15	17/27 in	0,8 ft	1,6 ft	7 Sheets
86-50-170/D15	2/3 in	0,8 ft	1,6 ft	6 Sheets
86-50-180/D15	17/24 in	0,8 ft	1,6 ft	6 Sheets
86-50-200/D15	37/47 in	0,8 ft	1,6 ft	5 Sheets



Cellpolyurethane Sheets RG 65

Basic material D15, 650 kg/m³

Item no.	Thickness	Width	Length	Packed by
86-65-020/D15	3/38 in	0,8 ft	1,6 ft	50 Sheets
86-65-030/D15	2/17 in	0,8 ft	1,6 ft	35 Sheets
86-65-040/D15	3/19 in	0,8 ft	1,6 ft	26 Sheets
86-65-050/D15	12/61 in	0,8 ft	1,6 ft	21 Sheets
86-65-060/D15	13/55 in	0,8 ft	1,6 ft	17 Sheets
86-65-070/D15	8/29 in	0,8 ft	1,6 ft	15 Sheets
86-65-080/D15	23/73 in	0,8 ft	1,6 ft	13 Sheets
86-65-090/D15	17/48 in	0,8 ft	1,6 ft	11 Sheets
86-65-095/D15	3/8 in	0,8 ft	1,6 ft	11 Sheets
86-65-100/D15	37/94 in	0,8 ft	1,6 ft	10 Sheets
86-65-110/D15	13/30 in	0,8 ft	1,6 ft	10 Sheets
86-65-150/D15	13/22 in	0,8 ft	1,6 ft	7 Sheets
86-65-160/D15	17/27 in	0,8 ft	1,6 ft	7 Sheets
86-65-170/D15	2/3 in	0,8 ft	1,6 ft	6 Sheets
86-65-180/D15	17/24 in	0,8 ft	1,6 ft	6 Sheets
86-65-190/D15	3/4 in	0,8 ft	1,6 ft	6 Sheets



Large formats possible for optimum utilization of materials for waterjet applications:

Cellpolyurethane Sheets RG 35

Basic material D15, 350 kg/m³

Item no.	Thickness	Width	Length	Packed by
86-35-070/D15.5	8/29 in	1,6 ft	1,6 ft	10 Sheets
86-35-100/D15.5	37/94 in	1,6 ft	1,6 ft	10 Sheets
86-35-150/D15.5	13/22 in	1,6 ft	1,6 ft	10 Sheets
86-35-160/D15.5	17/27 in	1,6 ft	1,6 ft	10 Sheets
86-35-170/D15.5	2/3 in	1,6 ft	1,6 ft	10 Sheets
86-35-190/D15.5	8/29 in	1,6 ft	1,6 ft	10 Sheets



Cellpolyurethane Sheets RG 50

Basic material D15, 500 kg/m³

Item no.	Thickness	Width	Length	Packed by
86-50-070/D15.5	8/29 in	1,6 ft	1,6 ft	10 Sheets
86-50-095/D15.5	3/8 in	1,6 ft	1,6 ft	10 Sheets
86-50-100/D15.5	37/94 in	1,6 ft	1,6 ft	10 Sheets
86-50-110/D15.5	13/30 in	1,6 ft	1,6 ft	10 Sheets
86-50-160/D15.5	17/27 in	1,6 ft	1,6 ft	10 Sheets
86-50-170/D15.5	2/3 in	1,6 ft	1,6 ft	10 Sheets
86-50-190/D15.5	3/4 in	1,6 ft	1,6 ft	10 Sheets



Cellpolyurethane Sheets RG 65

Basic material D15, 550 kg/m³

Item no.	Thickness	Width	Length	Packed by
86-65-070/D15.5	8/29 in	1,6 ft	1,6 ft	10 Sheets
86-65-100/D15.5	37/94 in	1,6 ft	1,6 ft	10 Sheets
86-65-170/D15.5	2/3 in	1,6 ft	1,6 ft	10 Sheets
86-65-190/D15.5	3/4 in	1,6 ft	1,6 ft	10 Sheets

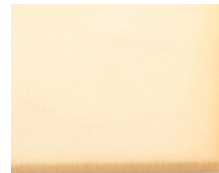

Cellpolyurethane Sheet RG 45 one side wavy

Basic material D15, 450 kg/m²

Item no.	Thickness	Width	Length	Packed by
86-45-175/D15.2	31/45 in	0,8 ft	1,6 ft	6 Sheets
86-45-190/D15.2	3/4 in	0,8 ft	1,6 ft	6 Sheets

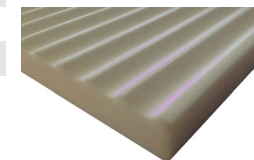

A&Max DRAGON

Basic material D15, 450 kg/m²

Item no.	Thickness	Width	Length	Packed by
86-45-175/D15.6	31/45 in	0,8 ft	1,6 ft	6 Sheets
86-45-190/D15.6	3/4 in	0,8 ft	1,6 ft	5 Sheets



A&M PTC



A&M PTC 20 Shore

Yellow

Item no.	Thickness	Width	Length	Packed by
86-PTC-20-080	23/73 in	1,6 ft	3,3 ft	10 Sheets
86-PTC-20-100	37/94 in	1,6 ft	3,3 ft	10 Sheets
86-PTC-20-110	13/30 in	1,6 ft	3,3 ft	10 Sheets
86-PTC-20-120	43/91 in	1,6 ft	3,3 ft	10 Sheets
86-PTC-20-140	43/78 in	1,6 ft	3,3 ft	10 Sheets
86-PTC-20-160	17/27 in	1,6 ft	3,3 ft	10 Sheets
86-PTC-20-200	37/47 in	1,6 ft	3,3 ft	10 Sheets



A&M PTC 25 Shore

Red

Item no.	Thickness	Width	Length	Packed by
86-PTC-25-080	23/73 in	1,6 ft	3,3 ft	10 Sheets
86-PTC-25-100	37/94 in	1,6 ft	3,3 ft	10 Sheets
86-PTC-25-110	13/30 in	1,6 ft	3,3 ft	10 Sheets
86-PTC-25-120	43/91 in	1,6 ft	3,3 ft	10 Sheets
86-PTC-25-140	43/78 in	1,6 ft	3,3 ft	10 Sheets
86-PTC-25-160	17/27 in	1,6 ft	3,3 ft	10 Sheets
86-PTC-25-200	37/47 in	1,6 ft	3,3 ft	10 Sheets



A&M PTC 30 Shore

Light blue

Item no.	Thickness	Width	Length	Packed by
86-PTC-30-080	23/73 in	1,6 ft	3,3 ft	10 Sheets
86-PTC-30-100	37/94 in	1,6 ft	3,3 ft	10 Sheets
86-PTC-30-110	13/30 in	1,6 ft	3,3 ft	10 Sheets
86-PTC-30-120	43/91 in	1,6 ft	3,3 ft	10 Sheets
86-PTC-30-140	43/78 in	1,6 ft	3,3 ft	10 Sheets
86-PTC-30-160	17/27 in	1,6 ft	3,3 ft	10 Sheets

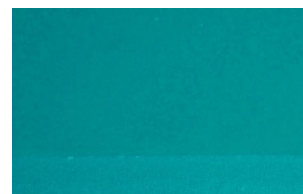

A&M PTC 35 Shore

Green

Item no.	Thickness	Width	Length	Packed by
86-PTC-35-080	23/73 in	1,6 ft	3,3 ft	10 Sheets
86-PTC-35-100	37/94 in	1,6 ft	3,3 ft	10 Sheets
86-PTC-35-110	13/30 in	1,6 ft	3,3 ft	10 Sheets
86-PTC-35-120	43/91 in	1,6 ft	3,3 ft	10 Sheets
86-PTC-35-140	43/78 in	1,6 ft	3,3 ft	10 Sheets
86-PTC-35-160	17/27 in	1,6 ft	3,3 ft	10 Sheets



A&M PTC 40 Shore

Orange

Item no.	Thickness	Width	Length	Packed by
86-PTC-40-080	23/73 in	1,6 ft	3,3 ft	10 Sheets
86-PTC-40-100	37/94 in	1,6 ft	3,3 ft	10 Sheets
86-PTC-40-110	13/30 in	1,6 ft	3,3 ft	10 Sheets
86-PTC-40-120	43/91 in	1,6 ft	3,3 ft	10 Sheets
86-PTC-40-140	43/78 in	1,6 ft	3,3 ft	10 Sheets
86-PTC-40-160	17/27 in	1,6 ft	3,3 ft	10 Sheets



A&M PTC 45 Shore

violet

Item no.	Thickness	Width	Length	Packed by
86-PTC-45-080	23/73 in	1,6 ft	3,3 ft	10 Sheets
86-PTC-45-100	37/94 in	1,6 ft	3,3 ft	10 Sheets
86-PTC-45-110	13/30 in	1,6 ft	3,3 ft	10 Sheets
86-PTC-45-120	43/91 in	1,6 ft	3,3 ft	10 Sheets
86-PTC-45-140	43/78 in	1,6 ft	3,3 ft	10 Sheets
86-PTC-45-160	17/27 in	1,6 ft	3,3 ft	10 Sheets



A&M Ecoject F

A&M Ecoject F 25 Shore

yellow

Item no.	Thickness	Width	Length	Packed by
83-EJ-25-080	23/73 in	3,3 ft	3,3 ft	1 Sheet
83-EJ-25-100	37/94 in	3,3 ft	3,3 ft	1 Sheet
83-EJ-25-110	13/30 in	3,3 ft	3,3 ft	1 Sheet
83-EJ-25-140	43/78 in	3,3 ft	3,3 ft	1 Sheet
83-EJ-25-160	17/27 in	3,3 ft	3,3 ft	1 Sheet



A&M Ecoject F 35 Shore

green

Item no.	Thickness	Width	Length	Packed by
83-EJ-35-080	23/73 in	3,3 ft	3,3 ft	1 Sheet
83-EJ-35-100	37/94 in	3,3 ft	3,3 ft	1 Sheet
83-EJ-35-110	13/30 in	3,3 ft	3,3 ft	1 Sheet
83-EJ-35-140	43/78 in	3,3 ft	3,3 ft	1 Sheet
83-EJ-35-160	17/27 in	3,3 ft	3,3 ft	1 Sheet

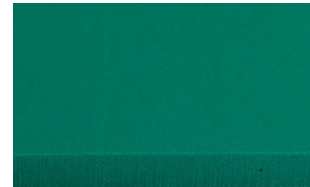

A&M Ecoject F 45 Shore

orange

Item no.	Thickness	Width	Length	Packed by
83-EJ-45-080	23/73 in	3,1 ft	3,2 ft	1 Sheet
83-EJ-45-100	37/94 in	3,1 ft	3,2 ft	1 Sheet
83-EJ-45-110	13/30 in	3,1 ft	3,2 ft	1 Sheet
83-EJ-45-140	43/78 in	3,1 ft	3,2 ft	1 Sheet
83-EJ-45-160	17/27 in	3,1 ft	3,2 ft	1 Sheet

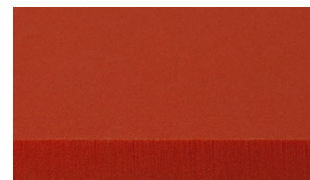



We make it happen

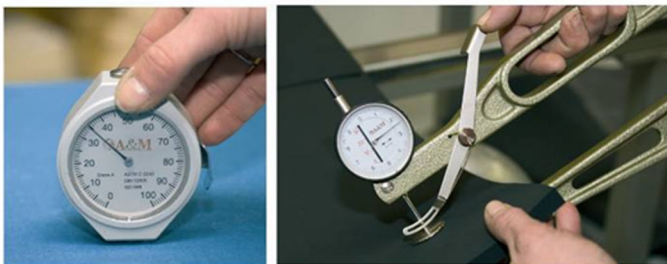
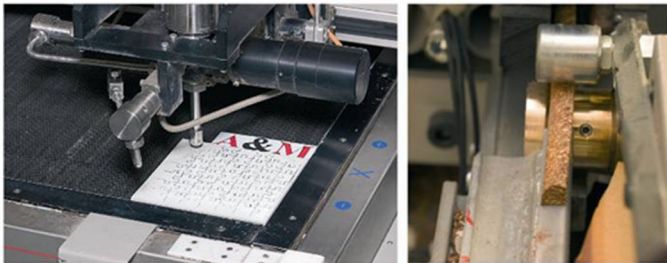

Processing and packaging to your specifications!

Some of our services include:

Self – Adhesive backing:

Item no.	Description	Packed by
80-SK.0125	Selfadhesive backing of ejektion material, 0,125 m ² sheets example Cellpolyurethane	From 8 Sheets
80-SK.0500	Selfadhesive backing of ejektion material, 0,5 m ² sheets example A&M Neo or Cellpolyurethane	From 10 Sheets
80-SK.1000	Selfadhesive backing of ejektion material, 1m ² sheets example Moosrubber or closed cell rubber	From 5 Sheets
80-SKJ.0125	Jetgluebacking of ejektion material, 0,125 m ² sheets example Cellpolyurethane	From 8 Sheets
80-SKJ.0500	Jetgluebacking of ejektion material, 0,5 m ² sheets Example A&M Neo or Cellpolyurethane	From 10 Sheets
80-SKJ.1000	Jetgluebacking of ejektion material, 1 m ² sheets Example Moosrubber or closed cell rubbers	From 5 Sheets

Cutting in strips:

0,125 m ² Sheets Example Cellpolyurethane	From 8 Sheet / s*
0,5 m ² Sheets Example A&M Neo or Cellpolyurethane	From 10 Sheet / s*
1 m ² Sheets Example Moosrubber or Cellpolyurethane	From 5 Sheets*

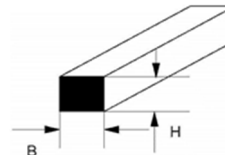

Cutting in trapez Strips:

0,125 m ² Sheets Example Cellpolyurethane	From 8 Sheet / s*
0,5 m ² Sheets Example A&M Neo or Cellpolyurethane	From 10 Sheet / s*
1 m ² Sheets Example Moosrubber or Cellpolyurethane	From 5 Sheets*

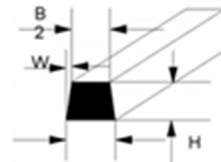

Cutting in one sided wavy strips:

0,125 m ² Sheets Example Cellpolyurethane	From 8 Sheet / s*
0,5 m ² Sheets Example A&M Neo or Cellpolyurethane	From 10 Sheet / s*
1 m ² Sheets Example Moosrubber or closed cell rubber	From 5 Sheets*

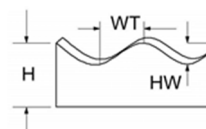

* Prices vary depending on the required parameters and materials. The quotation is per strip.

Our Standard - Strips

Open cell 25° Shore A

Item no.	Thickness	Width	Length	Packed by
S1.87-25-070070	8/29 in	8/29 in	1,6 ft	475 Strips
S1.87-25-100100	37/94 in	37/94 in	1,6 ft	240 Strips
S1.87-25-110110	13/30 in	13/30 in	1,6 ft	198 Strips

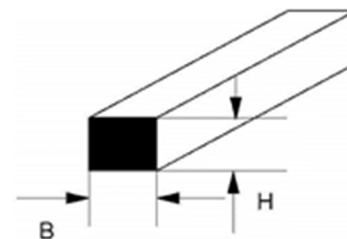

Open cell 25° Shore A Self - Adhesive

Item no.	Thickness	Width	Length	Packed by
S1.87-25-070070.SK	8/29 in	8/29 in	1,6 ft	475 Strips
S1.87-25-110110.SK	13/30 in	13/30 in	1,6 ft	198 Strips

Open cell 35° Shore A

Item no.	Thickness	Width	Length	Packed by
S1.87-35-070070	8/29 in	8/29 in	1,6 ft	475 Strips
S1.87-35-100100	37/94 in	37/94 in	1,6 ft	240 Strips

Open cell 35° Shore A Self - Adhesive

Item no.	Thickness	Width	Length	Packed by
S1.87-35-070070.SK	8/29 in	8/29 in	1,6 ft	475 Strips
S1.87-35-050070.SK	12/61 in	8/29 in	1,6 ft	576 Strips
S1.87-35-100100.SK	37/94 in	37/94 in	1,6 ft	240 Strips

Gasrubber **A&M**neo Self - Adhesive

One side with skin

Item no.	Thickness	Width	Length	Packed by
S1.83-17-110110/H.SK	13/30 in	13/30 in	1,6 ft	198 Strips

A&MG900

Item no.	Thickness	Width	Length	Packed by
S1.83-18-080080	23/73 in	23/73 in	1,6 ft	360 Strips
S1.83-18-100100	37/94 in	37/94 in	1,6 ft	240 Strips
S1.83-18-150150	13/22 in	13/22 in	1,6 ft	96 Strips

A&MG900 Self - Adhesive

Item no.	Thickness	Width	Length	Packed by
S1.83-18-080080.SK	23/73 in	23/73 in	1,6 ft	360 Strips
S1.83-18-110110.SK	13/30 in	13/30 in	1,6 ft	198 Strips

Our Standard - Strips

Cellpolyurethane RG 50

Basic material D15, 500 kg/m

Item no.	Thickness	Width	Length	Packed by
S1.86-50-020070	3/38 in	8/29 in	1,6 ft	210 Strips
S1.86-50-030070	2/17 in	8/29 in	1,6 ft	210 Strips
S1.86-50-040070	3/19 in	8/29 in	1,6 ft	210 Strips
S1.86-50-050070	12/61 in	8/29 in	1,6 ft	210 Strips
S1.86-50-060070	13/55 in	8/29 in	1,6 ft	210 Strips
S1.86-50-070070	8/29 in	8/29 in	1,6 ft	210 Strips
S1.86-50-080080	23/73 in	23/73 in	1,6 ft	217 Strips
S1.86-50-020100	3/38 in	37/94 in	1,6 ft	200 Strips
S1.86-50-030100	2/17 in	37/94 in	1,6 ft	200 Strips
S1.86-50-040100	3/19 in	37/94 in	1,6 ft	200 Strips
S1.86-50-050100	12/61 in	37/94 in	1,6 ft	200 Strips
S1.86-50-060100	13/55 in	37/94 in	1,6 ft	200 Strips
S1.86-50-100100	37/94 in	37/94 in	1,6 ft	240 Strips

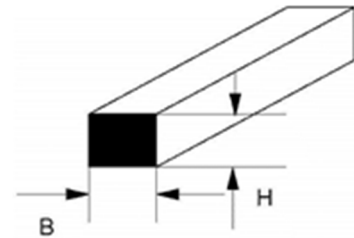

Cellpolyurethane RG 65

Basic material D15, 650 kg/m

Item no.	Thickness	Width	Length	Packed by
S1.86-65-020070	3/38 in	8/29 in	1,6 ft	210 Strips
S1.86-65-030070	2/17 in	8/29 in	1,6 ft	210 Strips
S1.86-65-040070	3/19 in	8/29 in	1,6 ft	210 Strips
S1.86-65-030100	2/17 in	37/94 in	1,6 ft	200 Strips
S1.86-65-040110	3/19 in	13/30 in	1,6 ft	198 Strips

Our Standard - Trapeze

Open cell 35° Shore A

Item no.	Thickness	Width 1	Width 2	Length	Packed by
S2.87-35-070/050/070	8/29 in	8/29 in	12/61 in	1,6 ft	560 Strips

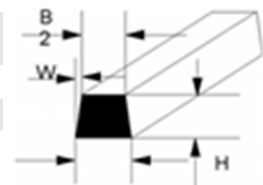

A&MG900

Item no.	Thickness	Width 1	Width 2	Length	Packed by
S2.83-18-110/100/120	13/30 in	43/91 in	37/94 in	1,6 ft in	180 Strips

A&MG900 Self - Adhesive

Item no.	Thickness	Width 1	Width 2	Length	Packed by
S2.83-18-110/100/120.SK	13/30 in	43/91 in	37/94 in	1,6 ft	180 Strips

Our Standard – Wavy Strips

Gasrubber **A&M**neo - Self - Adhesive

One side with skin

Item no.	Thickness	Width	WT	WH	Length	Packed by
S4.83-17-130110.SK	13/30 in	22/43 in	3/19 in	3/76 in	1,6 ft	171 Strips

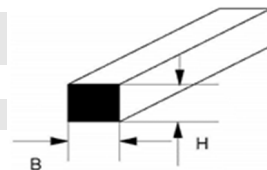

A&MG900

Item no.	Thickness	Width	WT	WH	Length	Packed by
S4.83-17-130110	13/30 in	22/43 in	3/19 in	3/76 in	1,6 ft	171 Strips

A&MG900 - Self - Adhesive

Item no.	Thickness	Width	WT	WH	Length	Packed by
S4.83-17-130110.SK	13/30 in	22/43 in	3/19 in	3/76 in	1,6 ft	171 Strips

The transverse elongation of ejection rubber and the distance to cutting rule.

Generally there must be a distance (gap) left between the cutting rule and the ejection rubber.

Otherwise the material will be forced tractive, which would have a negative influence on the die cutting results.

Which means - some cracks and deformation of the substrate material to cut.

Usually the distance corresponds to the thickness of the substrate.

maximum 5mm.

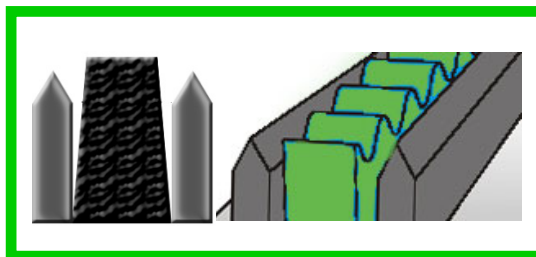
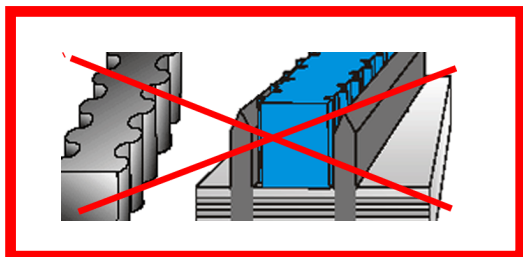

Foam Sheets / Strips

Foam RG 35, light blue

Item no.	Description	Packed by
85-35-400	Polyesterfoam Sheet RG 35 light blue height: 1 23/40 in, width 1,6 ft, length 3,3 ft	6,0 m ²
85-35-400.SK	Polyesterfoam Sheet RG 35 light blue with self-adhesive height: 1 23/40 in, width 1,6 ft, length 3,3 ft	6,0 m ²



Polyesterfoam – Strips RG35 Light Blue

Item no.	Description	Packed by
85-35-400.400	Polyesterfoam Strip RG 35 light blue height: 1 23/40 in, width 1 23/40 in, length 3,3 ft	144 Meter
85-35-400.500	Polyesterfoam Strip RG 35 light blue height: 1 31/32 in, width 1 23/40 in, length 3,3 ft	108 Meter
85-35-200.400.SK	Polyesterfoam Strip RG 35 light blue with self-adhesive height: 1 23/40 in, width 37/47 in, length 3,3 ft	288 Meter
85-35-250.400.SK	Polyesterfoam Strip RG 35 light blue with self-adhesive height: 1 23/40 in, width 62/63 in, length 3,3 ft	240 Meter
85-35-350.400.SK	Polyesterfoam Strip RG 35 light blue with self-adhesive height: 1 23/40 in, width 1 17/45 in, length 3,3 ft	168 Meter
85-35-400.400.SK	Polyesterfoam Strip RG 35 light blue with self-adhesive height: 1 23/40 in, width 1 23/40 in, length 3,3 ft	144 Meter
85-35-400.450.SK	Polyesterfoam Strip RG 35 light blue with self-adhesive height: 1 71/92 in, width 1 23/40 in, length 3,3 ft	132 Meter

Polyesterfoam Sheet RG 50 Yellow

Item no.	Description	Packed by
85-50-400	Polyesterfoam Sheet RG 50 yellow height: 1 23/40 in, width 1,6 ft, length 3,3 ft	6,0 m ²



Polyesterfoam - Strips RG 50 Yellow

Item no.	Description	Packed by
85-50-200.400	Polyesterfoam Strip RG 50 yellow height: 1 23/40 in, width 37/47 in, length 3,3 ft	168 Meter
85-50-400.400	Polyesterfoam Strip RG 50 yellow height: 1 23/40 in, width 1 23/40 in, length 3,3 ft	144 Meter
85-50-300.400.SK	Polyesterfoam Strip RG 50 yellow with self-adhesive height: 1 23/40 in, width 1 2/11 in, length 3,3 ft	192 Meter
85-50-400.400.SK	Polyesterfoam Strip RG 50 yellow with self-adhesive height: 1 23/40 in, width 1 23/40 in, length 3,3 ft	144 Meter

Stripping Foam RG 65, grey

Item no.	Description	Packed by
85-65-400	Polyesterfoam SHEet RG 65 grey height: 1 23/40 in, width 1,6 ft, length 3,3 ft	6,0 m ²



Stripping Foam - Strips RG 65 grey

Item no.	Description	Packed by
85-65-200.400	Polyesterfoam Strip RG 65 grey height: 1 23/40 in, width 37/47 in, length 3,3 ft	168 Meter
85-65-400.400	Polyesterfoam Strip RG 65 grey height: 1 23/40 in, width 1 23/40 in, length 3,3 ft	144 Meter
85-65-400.400.SK	Polyesterfoam Strip RG 65 grey with self-adhesive height: 1 23/40 in, width 1 23/40 in, length 3,3 ft	144 Meter

Stripping Kombifoam Soft (white/black) and medium (light blue/black)

Item no.	Description	Packed by
85-25-KF-400	Kombifoam Sheet RG25 white / RG65 black, 1 23/40 in x 1,6 ft x 3,3 ft	6,0 m ²
85-35-KF-400	Kombifoam Sheet RG35 lightblue / RG65 black, 1 23/40 in x 1,6 ft x 3,3 ft	6,0 m ²
85-25-KF-400.SK	Kombifoam Sheet RG25 white / RG65 black, selfadhesive, 1 23/40 in x 1,6 ft x 3,3 ft	6,0 m ²
85-35-KF-400.SK	Kombifoam Sheet RG35 lightblue / RG65 black, selfadhesive, 1 23/40 in x 1,6 ft x 3,3 ft	6,0 m ²



Stripping Kombifoam - Strips Soft (white/black) and medium (light blue/black)

Item no.	Description	Packed by
85-35-KF-400.400.SK	Kombifoam Strips RG35 lightblue / RG65 black, selfadhesive, height: 1 23/40 in, width: 1 23/40 in, length: 3,3 ft	144 Meter

A&M[®] QuickPick

Optimize your workflow

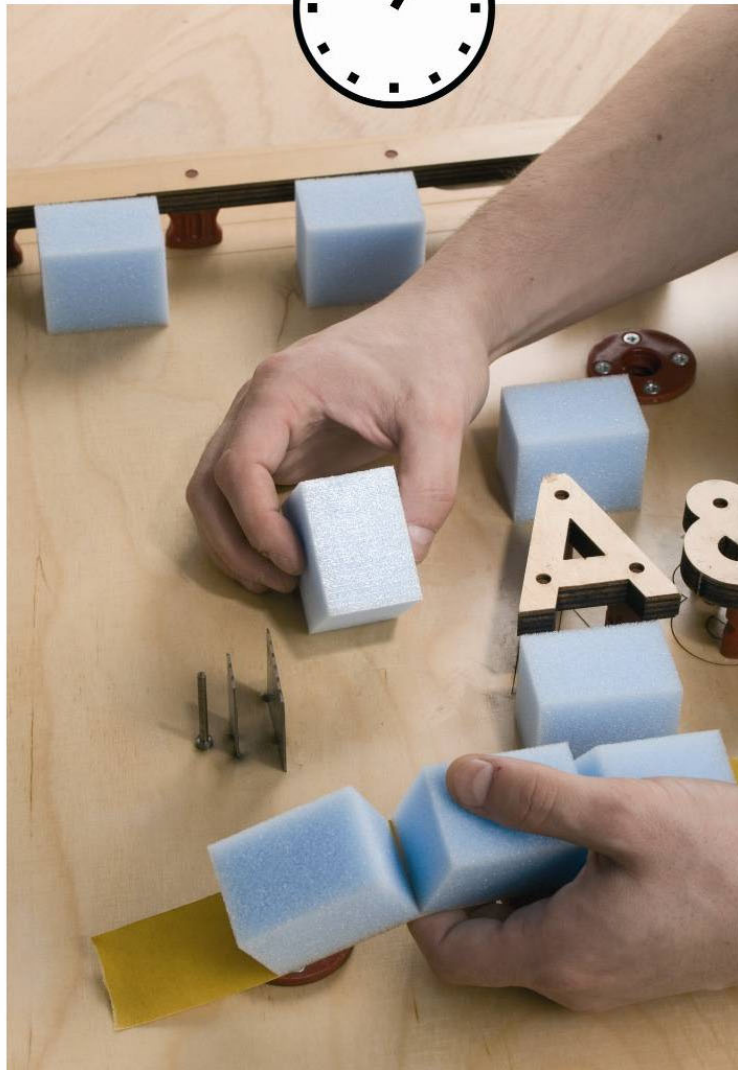

QUICKpick Polyester Foam (cubes)

Item no.	Description	Packed by
85-35-QP-30.35.40	QUICKpick stripping foam RG 35, lightblue, 1 2/11 x 1 17/45 x 1 23/40 in, self-adhesive, cubes in stripes 1 17/45 in x 3,2 ft x 1 23/40 in	168 Strips
85-35-QP-50.35.40	QUICKpick stripping foam RG 35, lightblue, 1 31/32 x 1 17/45 x 1 23/40 in, self-adhesive, cubes in stripes 1 17/45 in x 3,3 ft x 1 23/40 in	168 Strips
85-35-QP-75.35.40	QUICKpick stripping foam RG 35, lightblue, 2 20/21 x 1 17/45 x 1 23/40 in, self-adhesive, cubes in stripes 1 17/45 in x 3,3 ft x 1 23/40 in	168 Strips
85-35-QP-100.35.40	QUICKpick Stripping foam RG 35 lightblue 2 3 15/16 x 1 17/45 x 1 23/40 in, self-adhesive, cubes in stripes 1 17/45 in x 3,3 ft x 1 23/40 in	168 Strips
85-35-QP-100.35.45	QUICKpick Stripping foam RG 35 lightblue 2 3 15/16 x 1 17/45 x 1 71/92 in, self-adhesive, cubes in stripes 1 17/45 in x 3,1 ft x 1 71/92 in	154 Strips



QUICKpick Kombifoam (cubes)

Item no.	Description	Packed by
85-35-KF-QP-30.35.40	Kombifoam-QUICKpick RG35 lightblue / RG65 black 1 2/11 x 1 17/45 x 1 23/40 in, self-adhesive, cubes in stripes 1 17/45 in x 3,2 ft x 1 23/40 in	168 Strips
85-35-KF-QP-50.35.40	Kombifoam-QUICKpick RG35 lightblue / RG65 black 1 31/32 x 1 17/45 x 1 23/40 in, self-adhesive, cubes in stripes 1 17/45 in x 3,3 ft x 1 23/40 in	168 Strips
85-35-KF-QP-75.35.40	Kombifoam-QUICKpick RG35 lightblue / RG65 black 2 20/21 x 1 17/45 x 1 23/40 in, self-adhesive, cubes in stripes 1 17/45 in x 3,3 ft x 1 23/40 in	168 Strips

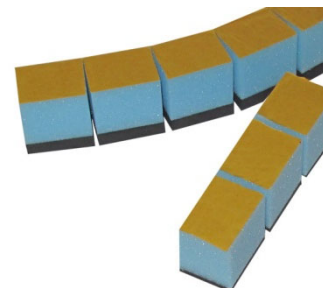

NK-Profile

For solid board

Item no.	Thickness	Width	Hardness	Colour	Packed by
80-NKC-070B78	8/29 in	18/59 in	70° Shore	White	100 Meter
80-NK-073B70BJ	2/7 in	23/73 in	70° Shore	White	100 Meter
80-NK-073B30	2/7 in	2/17 in	70° Shore	White	100 Meter
80-NK-073B50	2/7 in	12/61 in	70° Shore	White	100 Meter
80-NK-073T55	25/87 in	23/73 in	55° Shore	Black	100 Meter
80-NK-095B80	3/8 in	23/73 in	70° Shore	White	100 Meter

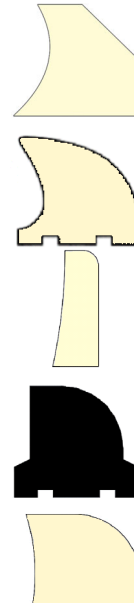

Rubbercork Profile 65° Shore A

For solid board, one side rounded, with stand off

Item no.	Thickness	Width	Length	Colour	Packed by
84-65-050/070P00	8/29 in	12/61 in	3,3 ft	Red-brown	50 Meter
84-65-070/070P00	8/29 in	8/29 in	3,3 ft	Red-brown	50 Meter
84-65-070/090P00	8/29 in	17/48 in	3,3 ft	Red-brown	50 Meter
84-65-080/070P00	8/29 in	23/73 in	3,3 ft	Red-brown	50 Meter
84-65-100/100P00	37/94 in	37/94 in	3,3 ft	Red-brown	50 Meter



Rubbercork Profile 65° Shore A

For solid board, one side rounded, without stand off

Item no.	Thickness	Width	Length	Colour	Packed by
84-65-070/070P01	8/29 in	8/29 in	3,3 ft	Red-brown	50 Meter
84-65-100/100P01	37/94 in	37/94 in	3,3 ft	Red-brown	50 Meter



Rubbercork Profile 65° Shore A

For solid board

Item no.	Thickness	Width	Length	Colour	Packed by
84-65-120/075CPS1	13/44 : 11/43 in	43/91 in	3,3 ft	Red-brown	50 Meter
84-65-120/070CPS2	8/29 : 13/55 in	43/91 in	3,3 ft	Red-brown	50 Meter
84-65-120/100CPS3	37/94 : 17/48 in	17/48 in	3,3 ft	Red-brown	50 Meter



Rubbercork Profile 65° Shore A

For solid board, one side beveled

Item no.	Thickness	Width	Length	Colour	Packed by
84-65-070/100PA1Q	8/29 in	37/94 in	3,3 ft	Red-brown	50 Meter
84-65-100/100PA1Q	37/94 in	37/94 in	3,3 ft	Red-brown	50 Meter



Cellpolyurethane Profile

For solid board, one side rounded, with stand off

Item no.	Thickness	Width	Length	RG	Packed by
86-65-070/070P01	8/29 in	8/29 in	3,3 ft	650 KG/m³	50 Meter
86-65-100/100P01	37/94 in	37/94 in	3,3 ft	650 KG/m³	50 Meter



Cellpolyurethane Profile

For solid board, one side rounded, without stand off

Item no.	Thickness	Width	Length	RG	Packed by
86-65-070/070P00	8/29 in	8/29 in	3,3 ft	650 KG/m³	50 Meter
86-65-080/070P00	8/29 in	23/73 in	3,3 ft	500 KG/m³	50 Meter
86-50-090/090P00	17/48 in	17/48 in	3,3 ft	500 KG/m³	50 Meter
86-35-100/100P00	37/94 in	37/94 in	3,3 ft	350 KG/m³	50 Meter
86-50-100/100P00	37/94 in	37/94 in	3,3 ft	500 KG/m³	50 Meter
86-65-100/100P00	37/94 in	37/94 in	3,3 ft	650 KG/m³	50 Meter
86-35-100/120P00	37/94 in	43/91 in	3,3 ft	350 KG/m³	50 Meter
86-50-120/100P00	37/94 in	43/91 in	3,3 ft	500 KG/m³	50 Meter
86-65-120/100P00	37/94 in	43/91 in	3,3 ft	650 KG/m³	50 Meter
86-35-130/130P00	22/43 in	22/43 in	3,3 ft	350 KG/m³	50 Meter
86-50-130/130P00	22/43 in	22/43 in	3,3 ft	500 KG/m³	50 Meter
86-35-140/140P00	43/78 in	43/78 in	3,3 ft	350 KG/m³	50 Meter
86-50-140/140P00	43/78 in	43/78 in	3,3 ft	500 KG/m³	50 Meter

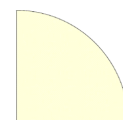

Closed Cell Rubberprofile

appr. 20° Shore A; one side rounded, with stand off

Item no.	Thickness	Width	Length	Colour	Packed by
83-16-120/130P00	43/91 in	22/43 in	40 Meter	Black	1 Reel



Closed Cell Rubberprofile

appr. 20° Shore A; one side rounded

Item no.	Thickness	Width	Length	Colour	Packed by
83-16-120/080P00	23/73 in	43/91 in	25 Meter	Black	1 Reel



Soft C Profile

appr. 25° Shore A; one side rounded

Item no.	Thickness	Width	Length	Colour	Packed by
80-CSC.065	11/43 in	23/73 in	30 Meter	Red	1 Reel
80-CSC.070	8/29 in	23/73 in	30 Meter	Red	1 Reel
80-CSC.075	13/44 in	23/73 in	30 Meter	Red	1 Reel
80-CSC.080	23/73 in	31/75 in	30 Meter	Red	1 Reel
80-CSC.090.M	17/48 in	31/75 in	1 Meter	Red	80 Meter
8β-CSC.095.M	3/8 in	31/75 in	1 Meter	Red	60 Meter
80-CSC.100.M	37/94 in	43/91 in	30 Meter	Red	1 Reel
80-CSC.110.M	13/30 in	43/91 in	30 Meter	Red	1 Reel
80-CSC.140	43/78 in	22/43 in	30 Meter	Red	1 Reel

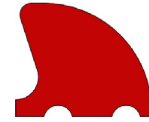

Cushion Crease

appr. 55° Shore A, white, colourcoded, extra soft for perfect creasing

Item no.	Thickness	Width	Colour	Packed by
80-CC-060	13/55 in	13/15 in	White/Grey	25 Meter
80-CC-065	11/43 in	13/15 in	White/Yellow	25 Meter
80-CC-070	8/29 in	13/15 in	White/Green	25 Meter
80-CC-075	13/44 in	13/15 in	White/Gold	25 Meter
80-CC-080	23/73 in	13/15 in	White/Blue	20 Meter
80-CC-085	1/3 in	13/15 in	White/Purple	20 Meter
80-CC-090	17/48 in	13/15 in	White/Orange	20 Meter
80-CC-100	37/94 in	13/15 in	White/Pink	15 Meter
80-CC-110	13/30 in	13/15 in	White/Beige	15 Meter



Easy Crease / XL

appr. 55° Shore A, black. colourcoded

Item no.	Thickness	Width	Colour	Packed by
80-EC-070	8/29 in	31/45 in	Black/Green	50 Meter
80-EC-075	13/44 in	67/91 in	Black/Gold	50 Meter
80-EC-080	23/73 in	37/47 in	Black/Blue	50 Meter
80-EC-085	1/3 in	43/52 in	Black/Purple	50 Meter
80-EC-090	17/48 in	13/22 in	Black/Black	50 Meter
80-EC-095	3/8 in	37/47 in	Black/White	50 Meter



Compact Polyurethane Profile

75° Shore A solid rubber D15

Item no.	Thickness	Width	Length	Packed by
80-VG-050/085/075	1/3 x 13/44 in	12/61 in	3,3 ft	100 Meter
80-VG-050/090/080	17/48 x 23/73 in	12/61 in	3,3 ft	100 Meter
80-VG-050/095/085	3/8 x 1/3 in	12/61 in	3,3 ft	100 Meter
80-VG-050/125/115	31/63 x 24/53 in	12/61 in	3,3 ft	100 Meter



Trapez Profile

appr.70° Shore A

Item no.	Thickness	Width	Length	Packed by
80-TP-090	17/48 : 13/55 in	43/91 in	2 ft	1 Pack / 30 Meter

**Rubber Profile**

A / 1; 70° Shore A

Item no.	Thickness	Width	Length	Packed by
80-VG-010/010	37/94 in	37/94 in	3,3 ft	50 Meter
80-VG-085/105	1/3 in	31/75 in	3,3 ft	50 Meter

**Rubber Profile**

A / 1; 70° Shore A with chamfered edge, black

Item no.	Thickness	Width	Length	Packed by
80-VG-010/010Q	37/94 in	37/94	3,3 ft	80 Meter
80-VG-085/105Q	1/3 in	31/75	3,3 ft	50 Meter

**Rubber Profile**

B / 2; 70° Shore A

Item no.	Thickness	Width	Length	Packed by
80-VG-070/125	8/29 in	31/63 in	3,3 ft	50 Meter
80-VG-075/125	13/44 in	31/63 in	3,3 ft	50 Meter

**Rubber Profile**

C / 3; 70° Shore A

Item no.	Thickness	Width	Length	Packed by
80-VG-070/125C	8/29 in	31/63 in	3,3 ft	50 Meter

**Rubber Profile**

C / 3 XL ; 70° Shore A

Item no.	Thickness	Width	Length	Packed by
80-C3-075	13/44 in	4/7 in	60 Meter	1 Reel
80-C3-085	1/3 in	4/7 in	3,3 ft	50 Meter

**Rubber Profile**

D / 4 ; 70° Shore A

Item no.	Thickness	Width	Length	Packed by
80-D4-100	37/94 in	62/63 in	3,3 ft	25 Meter
80-D4.100.S	37/94 in	43/52 in	3,3 ft	40 Meter



Rubber Profile

D / 5 ; 70° Shore A, black, colourcoded

Item no.	Thickness	Width	Length	Colour	Packed by
80-D5-060-050	13/55 in	17/90 in	3,3 ft	Black/Grey	100 Meter
80-D5-070-060	8/29 in	21/97 in	3,3 ft	Black/Yellow	100 Meter
80-D5-080-070	23/73 in	9/44 in	3,3 ft	Black/Blue	100 Meter
80-D5-085-075	1/3 in	21/97 in	3,3 ft	Black/Purple	100 Meter
80-D5-090-080	17/48 in	12/61 in	3,3 ft	Black/Orange	100 Meter
80-D5-095-085	3/8 in	9/44 in	3,3 ft	Black/White	100 Meter
80-D5-100-090	37/94 in	21/97 in	3,3 ft	Black/Heatherviolet	100 Meter
80-D5-110-100	13/30 in	12/61 in	3,3 ft	Black/Beige	100 Meter
80-D5-120-110	43/91 in	21/97 in	3,3 ft	Black/Lightblue	100 Meter



Rubber Profile

D / 5 T; 70° Shore A, black, colourcoded

Item no.	Thickness	Width	Length	Colour	Packed by
80-D5T-070	8/29 in	21/97 in	3,3 ft	Black/Heatherviolet	100 Meter
80-D5T-100	37/94 in	21/97 in	3,3 ft	Black/Yellow	100 Meter



Vulco-Crease

Cuneiform made of Polyurethane ; RG 35, 350KG/m³

Item no.	Thickness	Width	Length	Packed by
86-35-250/090P00	17/48 in	62/63 in	3,3 ft	50 Meter
86-35-250/100P00	37/94 in	62/63 in	3,3 ft	50 Meter
86-35-250/120P00	43/91 in	62/63 in	3,3 ft	50 Meter
86-35-250/140P00	43/78 in	62/63 in	3,3 ft	50 Meter



Glue

Item no.	Description	Packed by
88-11-050	A&M Powerglue , Cyanoacrylate based, power glue for all kinds of material, bonds in seconds bottle 1,76 oz	24 Bottles
88-05-002	Latex-milk (glue), for non-laminated die boards	2,6 gal
88-05-004	Die Glue (Type 6598) - standard, for laminates and not laminated die boards	11 lbs



Testing Equipment

Item no.	Description	Packed by
80-00-001	Hardness tester for Shore A	1 Pcs
80-00-002	Hardness tester for Shore 00	1 Pcs
80-00-003	Hardness tester for shore 0-30 mm, measuring depth 200 mm	1 Pcs



Cutting Rules

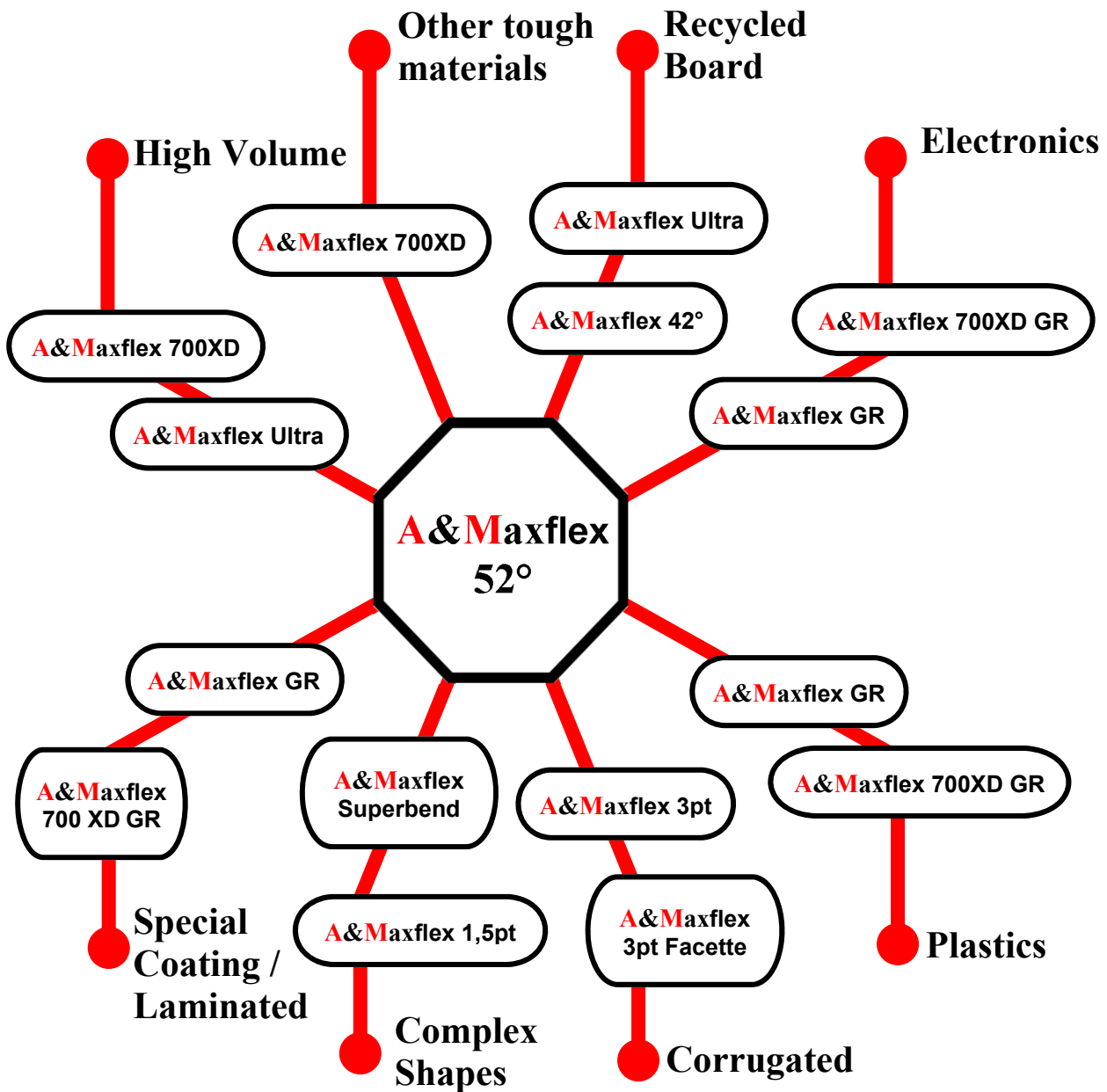

A&Maxflex 52

The A&Maxflex rule has a 52° cutting edge. The ideal combination of edge hardness and flexibility for die cutting a wide range of materials. The well controlled decarburisation allows a 2 Point rule to bent to a minimum of 150°.

Point Sizes:	1.5, 2, 3 and 4
Heights:	up to 1 31/32 inch
Availability:	Coils and metre lengths
Hardness:	2pt – Body: 40 HRC, Edge: 56 HRC 3/4pt – Body: 34 HRC, Edge: 56 HRC
Applications:	For solid and corrugated boards and all commonly used substrates.

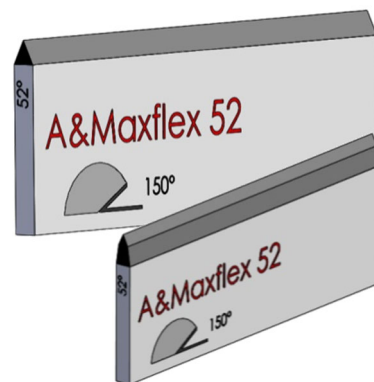

A&Maxflex 42

The 42° angle requires less cutting pressure which leads to a longer cutting life. The sharp cutting angle achieves easier penetration of the substrate, thereby reducing slivers, swarfs and dust.

A 2 Point rule can be bent to a minimum of 150°.

Point Sizes:	1.5, 2, 3 and 4
Heights:	up to 1 31/32 inch
Availability:	Coils and metre lengths
Hardness:	2pt – Body: 40 HRC, Edge: 56 HRC 3/4pt – Body: 34 HRC, Edge: 56 HRC
Applications:	Particularly suited for paper board and recycled board with a high dust content.

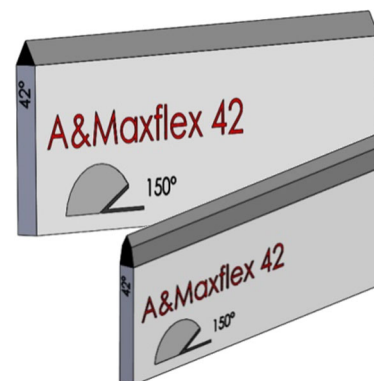

A&Maxflex Hard

Comes with all the A&Maxflex features, but with a harder body. It is ideal for dies that require less tight bends, but where greater body stability is essential. The A&Maxflex Hard will stand up to the toughest of substrates.

Point Sizes:	3 and 4
Heights:	up to 1 31/32 inch
Availability:	Coils and metre lengths
Hardness:	Body: 40 HRC, Edge: 56 HRC
Applications:	Suited for solid and corrugated boards, plastics and dense substrates



A&Maxflex 700XD

The 42° angle with deep edge hardening gives increased wear resistance. The edge hardness is 50% as deep as the A&Maxflex rule, significantly increasing die life on most applications.

Point Sizes:	2 and 3
Heights:	up to 1 31/32 inch
Availability:	Coils and metre lengths
Hardness:	Body: 40 HRC, Edge: 59 HRC
Applications:	For cutting abrasive materials such as gaskets and plastics.

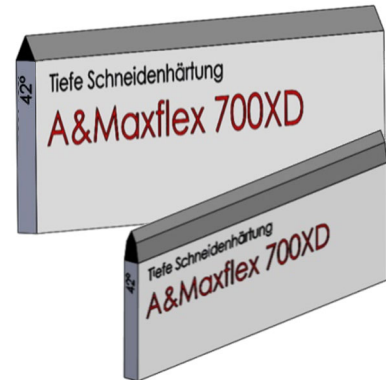

A&Maxflex Superbend

A slightly lower edge and body hardness gives greater bendability – up to 160°. A&Maxflex Superbend is ideal rule for the production of more complex shaped dies.

Point Sizes:	2 and 3
Heights:	up to 15/16 inch
Availability:	Coils and metre lengths
Hardness:	Body: 34 HRC, Edge: 55 HRC
Applications:	Particularly suitable for greeting cards, tickets and presentation work.



A&Maxflex Ultra

Comes with all the A&Maxflex features, but with a harder body. Available with both 42° and 52° edge, it's friction reducing coating gives easier penetration into the substrate. The cutting edge remains sharper longer. Gives considerable make-ready advantages, avoids costly downtime and reduce slivers and dust.

Point Sizes:	2,3 and 4
Heights:	up to 1 31/32 inch
Availability:	Coils and metre lengths
Hardness:	2 pt. Body: 40 HRC, Edge: 56 HRC 3/4 pt. Body: 34 HRC, Edge: 56 HRC
Applications:	A rule for solid and corrugated board. Ideally suited for food, pharmaceutical and medical packaging. For lung runs with reduced swarf contamination.

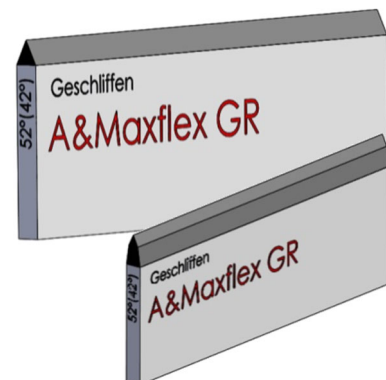

A&Maxflex GR

Comes with all the A&Maxflex features, but with a harder body. The A&Maxflex has a coarse surface finish on the edge, resulting in micro-teeth along the edge. These micro-teeth, along with the smaller edge radius makes it much sharper than the shaved edge.

Point Sizes:	1,5, 2 and 3
Heights:	up to 1 31/32 inch
Availability:	Coils and metre lengths
Hardness:	2 pt. Body: 40 HRC, Edge: 56 HRC 3/4 pt. Body: 34 HRC, Edge: 56 HRC
Applications:	Cutting materials such as plastics, plastic laminated boards and other difficult substrates.

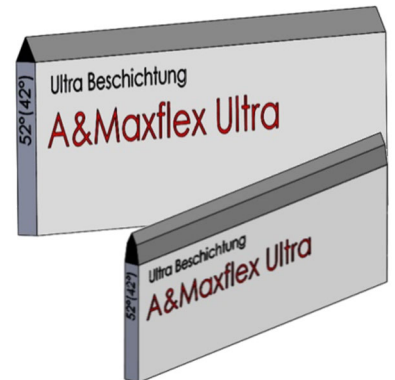

Edge configurations

The cutting rules are available in four distinct edge configurations.



Center Bevel



Side Bevel



Long Center Bevel



Long Side Bevel

Coil direction

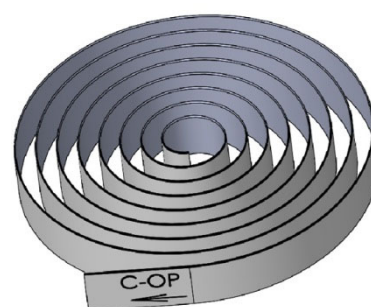
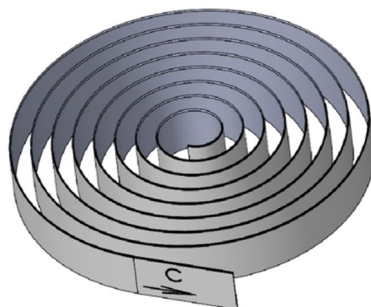

A&Maxflex Creasing Rules

A fine 'wrap-around' profile, eliminates any tendency of board cracking, caused by 'shoulders' on creasing rules with a flatter profile. The thickness is precisely compatible with our cutting rules.

- Point Sizes:** 2, 3, and 4,
- Heights:** up to 1 2/11 inch
- Availability:** Coils and metre lengths
- Hardness:** 40 HRC
- Applications:** A selection of creasing rules for all substrates.



A&Maxflex Cut Crease

Using special tooling to eliminate burrs on the crease height to achieve a clean edge. It is available in any cut and crease height where there is a requirement for the box work to fold easily. It is also used as reverse crease, aiding the reduction of material stress.

- Point Sizes:** 2, 3 and 4
- Heights:** up to 1 31/32 inch
- Availability:** Coils and metre lengths
- Hardness:** 2 pt.: 40 HRC
3/4 pt.: 34 HRC
- Applications:** Close ratio creasing e.g. gulleys.

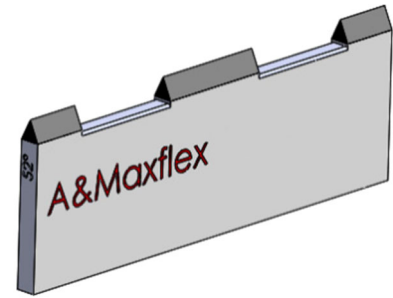

A&Maxflex Hand Hole Perforating

This rule is available in left and right hand configurations to create top or side access panels. Special hand hole perforating rules can also be manufactured to customer specific requirements. High precision rules made from edge hardened steel.

- Point Sizes:** 2, 3 and 4
- Heights:** up to 1 31/32 inch
- Availability:** Coils and metre lengths
- Hardness:** 2 pt. Body: 40 HRC, Edge: 56 HRC
3/4 pt. Body: 34 HRC, Edge: 56 HRC
- Applications:** Where fast, easy access to the product is required shelf ready packaging (SRP), point of sale packaging (POS). Other application include i.e. tissue boxes, confectionery boxes and tea bag cartons.



A&Maxflex Glue Flap Perforation

Glue flap perforating rule is a 2 x 2 point perforating rule waved to create a 'serpent' profile, that partially penetrates the substrate surface providing a 'key' for effective adhesion. 2 x 4 point and specials are available to suit specific applications.

Point Sizes:	2 and 3
Heights:	up to 1 31/32 inch
Availability:	Coils and metre lengths
Hardness:	40 HRC
Applications:	Glue flap panels.



A&Maxflex Perforation

Available in any tooth and gap configuration with a standard gap relief depth of 3mm. Other gap relief depths can also be manufactured. Precise manufacturing to eliminate burrs which avoids damage to the substrate and gives faster, cleaner runs.

Point Sizes:	2, 3 and 4
Heights:	up to 1 31/32 inch
Availability:	Coils and metre lengths
Hardness:	2 pt.: 40 HRC 3/4 pt.: 34 HRC
Applications:	Tear off labels, removable panels on paper, corrugated and solid board.

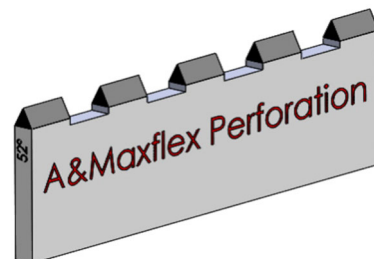

A&Maxflex Zipper Rules

A high precision rule made from edge hardened steel, which is precisely manufactured with accurate pitches, constant slit depth and dean edges to avoid any 'drag'. The different asymmetrical shapes shown on the right, are used in a left and right hand combination. There are three standard zipper rules, types A, B and C. A two way symmetrical alternative eliminates the need for left and right versions. By varying the required length ratios indicated on the right, different configurations can be achieved.

Point Sizes:	2, 3 and 4
Heights:	up to 1 31/32 inch
Availability:	Coils and metre lengths
Hardness:	2pt: Body: 40 HRC, Edge: 56 HRC 3/4pt: Body: 34 HRC, Edge: 56 HRC
Applications:	Used to create a tear strip on cartons to access the product.

A&M Maxflex Wave Rules

Edge hardened wave rules offer excellent bendability and high wear resistance. Special Wave Rules can be produced to customer's specific requirements.

Point Sizes:	2,3 and 4
Heights:	up to 1 31/32 inch
Availability:	Coils and metre lengths
Hardness:	2pt: Body: 40 HRC, Edge: 56 HRC 3/4pt: Body: 34 HRC, Edge: 56 HRC
Applications:	For better creasing in corrugated and fibre boards.

Benchtools and machinery

Item no.	Description
RB800	A&Max Bender with measuring gauge 500 mm, up to 3 pt, incl. tool set



RB800.WZ	Tools for A&Max Bender
----------	------------------------

	Tools for A&Max Bender
RB800WZ.X-M	R = 1,0 mm
RB800WZ.0-M	W = 40°
RB800WZ.1-M	W = 60°
RB800WZ.2-M	W = 90°
RB800WZ.3-M	R = 1,5 mm
RB800WZ.4-M	R = 2,0 mm
RB800WZ.5-M	R = 3,0 mm
RB800WZ.6-M	R = 4,0 mm
RB800WZ.7-M	R = 4,5 mm
RB800WZ.8-M	R = 6,5 mm
RB800WZ.9-M	R = 7,5 mm
RB800WZ.10-M	R = 9,0 mm
RB800WZ.0-F	R = 1,5 mm
RB800WZ.1-F	W = 60°
RB800WZ.2-F	W = 90°
RB800WZ.3-F	R = 2,35 mm
RB800WZ.4-F	R = 3,0 mm
RB800WZ.5-F	R = 3,9 mm
RB800WZ.6-F	R = 4,7 mm
RB800WZ.7-F	R = 6,3 mm
RB800WZ.8-F	R = 7,1 mm
RB800WZ.9-F	R = 8,5 mm
RB800WZ.10-F	R = 10,0 mm
RB800WZ.Y-F	W = 90°

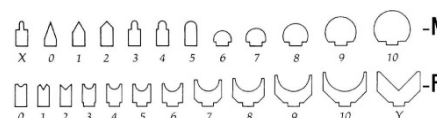

SR500	A&Max Cutter with measuring gauge 500 mm, max. 50mm height, 3pt
-------	---



SR500.WZ	Cutting Knives for A&Max Cutter
----------	---------------------------------



Benchtools and machinery

Item no.	Description
----------	-------------

NM400	A&Max Notcher for rules max. 4pt. 40 mm max., with measuring gauge 500 mm -Without tools-
-------	--



Notching tools

NM400WZ-4	4 mm Round
NM400WZ-4.1	4 mm square
NM400WZ-6	6 mm Round
NM400WZ-6.1	6 mm square
NM400WZ-8	8 mm Round
NM400WZ-8.1	8 mm square
NM400WZ-10	10 mm Round
NM400WZ-10.1	10 mm square



LM200-54	A&Max Lip-Cutter 54° up to max. 4pt./ 30 mm Rules, with measuring gauge 500 mm
----------	--



LM200WZ-54	Cutting Knives for A&Max Lip-Cutter
------------	-------------------------------------



50-20-001	Biegestar manual Bender for toothed rotary rules
-----------	--



FB001	Foot Bending machine A&Max Bender for rules max. 3pt. with measuring gauge, incl. toolset
-------	---



Storage system for stereos



- The system is **modular**. With customized aluminium - pfiles and racks it can fit to any different needs
- The aluminium profiles are **easy to mount** and fit into other rack systems as well.

Stereo transport trolley



- Transport up to 60 stereos at once!
- Height and length can be fitted to customer needs on request.
- Maximum load capacity 500 Kg.

Storage system for flat bed dies

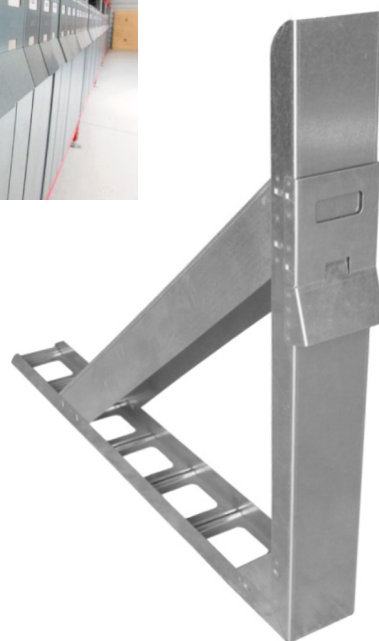

The Storage system for flat bed dies
Is easy to fit to different customer needs.

To name some advantages:

- Fast, save and easy handling of dies.
- Handling of complete sets.
- Highly ergonomic.
- No transport damages.
- Easy access to the dies.

Item no.	Description	Width	Height	Depth
31-12-001	Toolbox 1, galvanized	170 mm	800 mm	1100 mm
31-12-003	Toolbox 2, galvanized	170 mm	1000 mm	1250 mm
31-12-006	Toolbox 3, galvanized	170 mm	1200 mm	1600 mm

Transport trolley for dies



- Quick and secure transport of flat bed dies
- Available for all formats
- Prevents damages



Welcome to the all new **DieGuard 2.0!**

Our mission with developing, building and presenting the **DieGuard 2.0:**

Reducing machine down times to a bare minimum to avoid additional costs.





To achieve this goal, the **DieGuard 2.0** features **high-quality equipment** only. To name a few:

- LM200-54 **A&Max** Lip-Cutter
- NCZ-004 **A&Max** Matrix Chamfering Cutter
- NM-400 **A&Max** Notcher
- RB800 **A&Max** Bender
- 50-00-028 **A&Max**tractor Rule Puller
- 55-00-007.50/8 **A&Max** Grinder P

Fitted with all the special requirements and equipment the **DieGuard 2.0** will become the **machine operators best friend.**

I. General

1. The following General Terms and Conditions of Sale and Delivery (hereinafter "GTC") apply to all our business relationships with our customers (hereinafter "Customer") concerning the sale and/or delivery of movable goods (hereinafter "Goods"). The GTC apply only if the customer is an entrepreneur within the meaning of § 14 of the German Civil Code (BGB), a public law legal entity or a special public fund. The GTC in the version valid at the time of the customer's order or, in any case, in the version last communicated to him/her in writing, shall also apply to all future contracts without the need for them to be agreed upon again and without the need to be pointed out again for each further contract concluded.

2. In relation to our customers, only our GTC apply. Deviating, conflicting or supplementary general terms and conditions of the customer or parts thereof shall only become part of the contract if we have expressly agreed to their validity. This requirement for consent applies in any case, in particular even if we exclude the customer's order without reservation, despite knowledge of conflicting or deviating conditions of the customer.

3. In the contracts, all agreements made between the customer and us to fulfill the obligations of performance are recorded in writing. Individually agreed upon terms with the customer shall take precedence over these GTC. For such agreements, subject to contrary evidence, a written contract or written confirmation is decisive.

4. Declarations and notifications (e.g. defect notices, deadlines, declarations on legal consequences, etc.) to be made by the customer to us after conclusion of the contract shall require the text form for their effectiveness.

5. The customer agrees that we may process data obtained in connection with the business relationship, whether obtained from the contracting partner itself or from third parties, in accordance with the General Data Protection Regulation (GDPR) and the Federal Data Protection Act (BDSG).

II. Offer and Conclusion of Contract

1. All offers are non-binding and subject to change unless we have expressly designated them as binding in writing. This also applies to catalogs, technical documentation (e.g. drawings, plans, calculations, etc.), other product descriptions or documents, even if they have been directly provided to the customer. If we have expressly marked offers as binding, we are bound by them for a period of 30 days.

2. Technical changes as well as changes in shape, color, and/or weight are reserved within reasonable limits, especially for new constructions and special designs. We are entitled to subcontract.

3. The customer's order of the goods constitutes a binding offer to conclude a contract. Unless the order indicates otherwise, we are entitled to accept this offer within 2 weeks of receipt by sending an order confirmation or by sending the ordered products within the same period.

4. We reserve all our proprietary, copyright, and other protective rights to all catalogs, technical documentation, drawings, plans, illustrations, calculations, offers, as well as other documents, samples, models, tools, and other objects provided by us. The customer may not make these accessible to third parties either as such or in content without our written consent, nor pass them on to third parties, nor use or reproduce them themselves or through third parties, regardless of whether we have designated them as confidential or binding. On our request, the customer must return these objects to us in full and destroy any copies made if they are no longer required by him in the regular course of business or if negotiations do not lead to the conclusion of a contract.

III. Prices and Payment Conditions

1. Unless agreed otherwise or specified in the order confirmation, our current list prices from the factory apply without packaging at the time of contract conclusion. Our prices are subject to the applicable statutory value-added tax (which we will separately indicate in the invoice) and packaging.

2. Our prices are valid for one month from the date of contract conclusion, unless otherwise agreed explicitly. For contracts with a delivery period of more than four months or for continuous obligations lasting longer than four months, we reserve the right to pass on any cost increases that occur during the procurement/delivery process, including price increases resulting from changes in the law, to the customer to the corresponding extent.

3. If the customer wishes for the goods to be shipped (a contract of sale involving the shipment of goods, cf. § 4 (1)), the customer shall bear the transport costs from the factory and the costs of any transport insurance requested by the customer. The customer shall also bear any customs duties, fees, taxes, and other public charges.

4. The invoice amount shall be due and payable in full without deduction within 14 days of receipt of the invoice, unless otherwise specified in the order confirmation. Payment shall only be deemed to have been made when we are able to dispose of the amount. We reserve the right to accept checks on a case-by-case basis, but generally only for fulfillment purposes. We do not guarantee timely collection or timely protest. In the case of check payments, payment shall be deemed to have been made only when the check is honored. We have eight days after receipt to honor the check.

5. In the course of ongoing business relationships, we reserve the right to make deliveries fully or partially only against advance payment. This reservation shall be made no later than with the order confirmation. If the customer is in default of payment for a previous delivery, we are entitled to withhold deliveries without being obliged to compensate for any damages.

6. If the customer is in default of payment, we are entitled to charge interest from the time of default at the applicable statutory default interest rate, but at least 9 percentage points above the respective base interest rate of the European Central Bank (ECB). We reserve the right to claim higher damages. Our claim for commercial default interest (§ 353 HGB) against merchants remains unaffected.

7. In the event that a check is not honored on time or a significant deterioration of the customer's financial position occurs or threatens to occur, we are entitled to demand immediate payment of the entire amount due, even if checks have been issued. If the customer cancels an order for which production has already begun, we reserve the right to charge for the goods commensurate with the stage of production. If, after the conclusion of the contract, it becomes apparent (e.g., through an application for the opening of insolvency proceedings) that our claim to the purchase price is at risk due to the customer's lack of solvency, we are entitled, in accordance with the statutory provisions, to refuse performance and, if necessary, to withdraw from the contract (§ 321 BGB).

8. The customer is only entitled to set-off, even if complaints or counterclaims are made, if the counterclaims have been legally established, recognized by us or undisputed. The customer is only authorized to exercise a right of retention if their counterclaim is based on the same contractual relationship.

IV. Delivery and performance time, default

1. Delivery dates or deadlines that have not been expressly agreed as binding are exclusively non-binding information. The delivery time specified by us only begins once technical issues have been clarified. Similarly, the customer must fulfill all obligations incumbent upon them in a proper and timely manner. If, in the case of call-off or scheduled orders, only part of the agreed quantity is taken within the agreed period, we will generally demand the total purchase price in exchange for the complete delivery of the ordered goods.

2. If we are in default with a binding deadline, the customer must grant us a reasonable grace period - starting from the day on which the written notice of default is received by us or, in the case of a deadline specified in calendar terms, from the expiry of the deadline - in writing. If this grace period elapses fruitlessly, the customer is entitled to withdraw from the contract. The customer's claims for default of delivery are governed by clause VII; otherwise, the statutory provisions apply.

3. Further liability for default of delivery attributable to us is excluded. The customer's further statutory claims and rights, which exist in addition to the claim for damages due to default of delivery attributable to us, remain unaffected.

4. If binding delivery deadlines cannot be met for reasons that are not our responsibility (unavailability of the service, delay in the delivery of the ordered and necessary materials due to warlike events in supplier countries, embargo or pandemic-related reasons or similar), we will immediately inform the customer of this and at the same time communicate the expected new delivery deadline. If the service is not available within the new delivery deadline, both parties are entitled to withdraw from the contract in whole or in part, depending on the stage of performance; we will immediately reimburse any consideration already provided by the customer without us having performed. In particular, failure to provide the service on time by our supplier shall be deemed to be a case of unavailability of the service within the meaning of this provision, if we have concluded a congruent cover transaction, neither we nor our supplier are at fault, or we are not obliged to procure the goods in the individual case.

5. The occurrence of our delivery delay is determined by legal regulations. A reminder by the customer is always required.

6. The customer's rights according to § 8 of these terms and conditions and our legal rights, in particular in the event of exclusion of the obligation to perform (e.g. due to impossibility or unreasonableness of performance and/or subsequent performance), remain unaffected.

7. We are entitled to partial deliveries and partial performances at any time.

8. If the customer is in default of acceptance, we are entitled to demand compensation for the resulting damage and any additional expenses. The same applies if the customer culpably breaches his or her duty to cooperate. With the occurrence of the acceptance or debtor delay, the risk of accidental deterioration and accidental loss passes to the customer.

9. Unless otherwise agreed, delivery shall be made ex works, where the place of performance for delivery and any subsequent performance is also located. Upon the customer's request and at the customer's expense, the goods shall be shipped to another place of destination (sale by dispatch) and insured. Unless otherwise agreed, we are entitled to determine the type of dispatch (in particular transport companies, shipping route, packaging) ourselves.

10. If our performance requires acceptance under statutory provisions or on the basis of an expressly applicable contractual agreement, the following shall apply: our performance shall be deemed accepted at the latest if and to the extent that

- the goods produced or processed by us are sold or made available for use by the customer to a third party after delivery, or
- the goods produced or processed by us are processed, mixed or connected with other goods with the customer's approval, or
- the goods produced or processed by us are used by the customer or third parties with the customer's approval beyond a trial period, or
- the performance is accepted by the customer's purchaser. An earlier acceptance deadline resulting from statutory provisions or individual agreements shall remain unaffected. Acceptance must be carried out immediately on the acceptance date, or alternatively, after the notification of readiness for acceptance. The customer may not refuse acceptance in the event of a non-material defect. 11. Confirmation of Arrival For deliveries to an EU member state outside of Germany, the customer must provide confirmation of arrival in accordance with the requirements of § 17a of the German VAT implementation regulation (USIDV) in its currently valid version, confirming that the goods have arrived in the rest of the Community. The confirmation of arrival must be signed by hand or transmitted electronically.

V. Transfer of risk/shipping/packaging

1. The risk of accidental loss and deterioration of the goods, including for sample deliveries, passes to the buyer at the latest upon delivery. In the case of a sale involving shipment, the risk of accidental loss and deterioration of the goods, as well as the risk of delay, passes to the carrier, freight forwarder or other person or entity designated to carry out the shipment upon delivery of the goods. If acceptance has been agreed upon, it is decisive for the transfer of risk. The statutory provisions of contract law for work contracts also apply to agreed-upon acceptance. If the buyer is in default of acceptance, this is equivalent to delivery or acceptance.

2. Loading and shipment are uninsured and at the customer's risk. We will make every effort to consider the

customer's wishes and interests regarding the method and route of shipment, but any additional costs - even for agreed-upon free delivery - are borne by the customer.

3. We do not take back transport and other packaging in accordance with the Packaging Ordinance. The customer is responsible for disposing of the packaging at their own expense.

4. If shipping is delayed at the customer's request or fault, we will store the goods at the customer's expense and risk. In this case, notification of readiness for shipment is equivalent to shipment.

5. At the customer's request and expense, we will secure the delivery with transport insurance.

VI. Warranty/Guarantee

1. The statutory provisions shall apply to the customer's rights in case of defects and legal defects, unless otherwise provided below.

2. The customer's claims for defects exist only if the customer has properly fulfilled his obligation to inspect and give notice of defects as required under § 377 HGB, unless the defect was fraudulently concealed. Contrary to § 438 (1) no. 3 BGB or § 634a (1) no. 3 BGB, the general limitation period for claims arising from defects and legal defects is one year from the transfer of risk.

3. If, despite all due care, the delivered goods have a defect that existed at the time of the transfer of risk, we will, subject to timely notice of defects, either remedy the defect or deliver replacement goods at our discretion. We must always be given the opportunity to remedy the defect within a reasonable period of time. Claims for recourse remain unaffected by the above regulation. If the attempt at subsequent performance fails, the customer may, at his discretion, demand a reduction in the price or rescission of the contract, without prejudice to any claims for damages. The attempt at subsequent performance shall be deemed to have failed after the second unsuccessful attempt, unless the nature of the item or defect or other circumstances indicate otherwise.

4. Claims for defects do not exist in the case of only insignificant deviations from the agreed quality, only insignificant impairment of usability, natural wear and tear or damage that arises after the transfer of risk due to faulty or negligent handling, excessive use, unsuitable operating materials or due to special external influences that were not assumed under the contract.

5. If repair work or modifications are carried out improperly by the customer or third parties, there are also no claims for defects for these and the resulting consequences.

6. The customer's claims for necessary expenses incurred for the purpose of subsequent performance, in particular transport, travel, labor and material costs, are excluded to the extent that the expenses increase because the goods delivered by us are subsequently taken to a location other than the customer's branch, unless the transportation corresponds to their intended use.

7. The customer's recourse claims against us only exist to the extent that the customer has not made any agreements with its buyer that go beyond the legally mandatory warranty claims. Furthermore, paragraph 6 shall apply accordingly to the extent of the customer's recourse claim against the supplier. Claims for damages due to a defect shall be determined according to VII, and otherwise according to the statutory provisions.

8. We are entitled to make the owed subsequent performance dependent on the customer paying the due purchase price. However, the customer is entitled to withhold a proportionate part of the purchase price in relation to the defect. The subsequent performance does not include the removal of the defective item nor the reinstallation if we were not originally obligated to install it.

9. The customer must provide us with the necessary time and opportunity for the owed subsequent performance, in particular by handing over the contested goods for testing purposes. In the case of replacement delivery, the customer must return the defective item to us in accordance with the statutory provisions.

VII. Liability

1. Unless otherwise stated in these terms and conditions, including the following provisions, we are liable for a breach of contractual and non-contractual obligations in accordance with statutory provisions.

2. We are liable for damages - regardless of the legal grounds - within the scope of fault-based liability for intentional and grossly negligent conduct.

3. In the case of ordinary negligence, we shall be liable, subject to a less strict liability standard according to statutory provisions (e.g. for care in our own affairs), only for damages arising from the breach of life, body or health or from a significant breach of a material contractual obligation (an obligation whose fulfillment makes the proper execution of the contract possible in the first place and on whose compliance the contracting party can regularly rely and trust); in this case, however, our liability is limited to the foreseeable, typically occurring damages.

4. The liability limitations arising from these regulations, particularly under 3., also apply in the event of a breach of duty by or in favour of persons whose fault we are responsible for according to statutory provisions. They do not apply in cases where we have fraudulently concealed a defect or provided a warranty for the quality of the goods, or in cases of claims by the customer under the Product Liability Act.

5. In the case of a breach of duty that does not constitute a defect, the customer may only withdraw or terminate the contract if we are responsible for the breach. Otherwise, the legal requirements and consequences apply.

VIII. Retention of Title

1. Until all claims, including all current and future balance claims from current accounts, which we have against the customer, have been fulfilled, the delivered goods (reserved goods) remain our property. In case of the customer's contractual breach, such as default of payment, we have the right to reclaim the reserved goods after setting an appropriate deadline. Reclaiming the reserved goods constitutes a withdrawal from the contract. If the customer returns the reserved goods, this is also a withdrawal from the contract. We are entitled to dispose of the reserved goods after reclamation. After deducting a reasonable amount for the costs of disposal, the proceeds from disposal are to be offset against the amounts owed to us.

2. The customer must handle the reserved goods with care and adequately insure them against fire and theft at his own expense up to the new value. Maintenance and inspection work that was necessary must be carried out by the customer in a timely manner at his own expense.

3. The customer is entitled to resell and/or use the reserved goods properly in the course of business as long as he is not in default of payment. Pledges or transfers of ownership for security purposes are not permitted. The customer hereby assigns to us all claims (including all current and future balance claims from current accounts) arising from the resale or any other legal basis (insurance, tort) regarding the reserved goods as security in full; we hereby accept the assignment. We authorize the customer to collect the assigned claims on our behalf in his own name, subject to revocation at any time if the customer does not fulfill his payment obligations properly. The customer is not authorized to assign these claims for the purpose of factoring unless the obligation of the factor to effect the consideration in the amount of the claims directly to us as long as claims against the customer exist is established at the same time.

4. Processing or transformation of the reserved goods by the customer is always carried out on our behalf. If the reserved goods are processed together with other items not belonging to us, we acquire co-ownership of the new item in proportion to the value of the reserved goods (invoice amount including value-added tax) compared to the other processing items at the time of processing. The same applies to the new item resulting from processing. In the case of the inseparable mixing of the reserved goods with other items not belonging to us, we acquire co-ownership of the new item in proportion to the value of the reserved goods (invoice amount including value-added tax) compared to the other mixed items at the time of mixing. If the customer's item is to be regarded as the main item as a result of mixing, the customer and we agree that the customer transfers co-ownership of this item to us in proportion to our co-ownership; we hereby accept the transfer. The customer shall keep our sole or co-ownership of an item created in this way for us.

5. In case of third-party access to the reserved goods, particularly seizures, the customer must notify us immediately and point out our ownership so that we can assert our ownership rights. If the third party is unable to reimburse us for the judicial or extrajudicial costs incurred in this context, the customer shall be liable for this.

6. We are obligated to release the securities to which we are entitled to the extent that the realizable value of our securities exceeds the claims to be secured by more than 10%, with the selection of the securities to be released being our responsibility.

IX. Place of performance, jurisdiction, applicable law

1. The place of performance and jurisdiction for deliveries and payments (including check and bill of exchange claims) as well as all disputes arising between us and the customer from the purchase agreements concluded between them and us is our place of business, Kernen im Remstal, or the competent courts for this location. However, we are also entitled to sue the customer at their place of residence and/or business. Mandatory legal provisions, in particular regarding exclusive jurisdictions, remain unaffected.

2. The relationship between the contracting parties is governed exclusively by the law in force in the Federal Republic of Germany. The application of the UN Convention on Contracts for the International Sale of Goods (CISG) is excluded.